



SUBMERSIBLE PUMPS FOR DRAINAGE WATER



NOVA 200

Pumpbody, impeller, cap and suction grid in technopolymer. Motor, rotor shaft and screws in stainless steel.

Triple O-ring seal interposed with an oil precombustion chamber. Continuous duty submersible asynchronous motor. Stator fitted in an airtight stainless steel casing.

Rotor mounted on overdimensioned, greased-for-life ball bearings. Built-in thermal and current overload protection and a capacitor permanently on in the single-phase version. For the protection of the three-phase motor it is advisable to use a suitable overload protection complying with the regulations in force. Supplied with standard power cables for the single-phase version:

5 metres H05RN-F for: NOVA 180 M-A

NOVA 300 M-A

NOVA 600 M-A

10 metres H05RN-F for: NOVA 180 M-NA

NOVA 200 M-NA

10 metres H07RN-F for: NOVA 600 M-NA

Standard cables supplied for the three-phase version: 5 metres of H07RN-F cable. For the single phase the standard is a SCHUKO plug EEC VII.

For special version available with special stainless steel motor shaft.

Operating range: from 1 to 16 m³/h with head up to 10.2 metres.

Liquid temperature range: from 0°C to +35°C for domestic use.

Pumped liquid characteristics:

NOVA fibre-less murky water.

Granulometric passage through the suction grid:

NOVA 180-NOVA 200 5 mm.

NOVA 300 – NOVA 600 10 mm.

Min. suction depth:

NOVA 180 A 77 mm.

NOVA 180 NA – NOVA 200 8 mm.

NOVA 300 85 mm.

NOVA 600 A 175 mm.

NOVA 600 NA 38 mm.

Maximum immersion depth: 7 metres.

Maximum dry running time: 1 minute.

Protection level: IP 68.

Insulation class: F.

TECHNICAL DATA

MODEL	CODE	ELECTRICAL DATA				
		VOLTAGE 50 HZ	P1 MAX kW	P2 NOMINAL		In A
				kW	HP	
NOVA 180 M-A	103022814	1X220-240 V~	0,19	0,2	0,28	0,9
NOVA 180 M-NA	103022944	1X220-240 V~	0,19	0,2	0,28	0,9
NOVA 200 M-NA	103022624	1X220-240 V~	0,35	0,22	0,3	1,5
NOVA 300 M-A	103022014	1X220-240 V~	0,35	0,22	0,3	1,6
NOVA 600 M-A	103022414	1X220-240 V~	0,80	0,55	0,75	3,4
NOVA 600 M-NA	103022584	1X220-240 V~	0,80	0,55	0,75	3,4
NOVA 600 T-NA	103000064	3X400 V~	0,80	0,55	0,75	1,6

A= automatic with float NA= non automatic without float

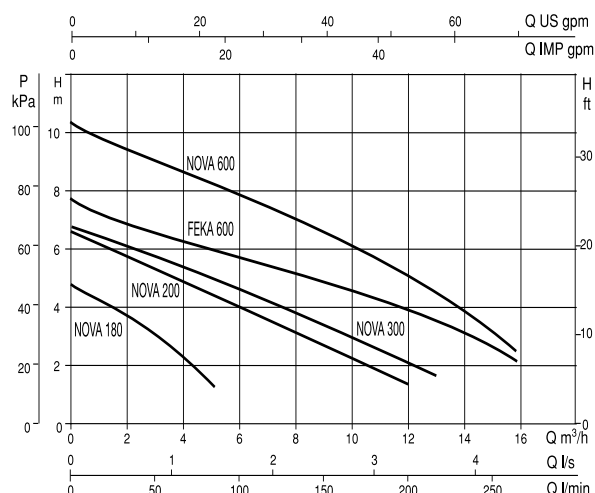

SPECIAL VERSION with a special stainless steel motor shaft

MODEL	CODE	ELECTRICAL DATA				
		VOLTAGE 50 HZ	P1 MAX kW	P2 NOMINAL		In A
				kW	HP	
NOVA 180 M-A - SV	103002684	1X220-240 V~	0,19	0,2	0,28	0,9
NOVA 180 M-NA - SV	103002694	1X220-240 V~	0,19	0,2	0,28	0,9
NOVA 200 M-NA - SV	103002704	1X220-240 V~	0,35	0,22	0,3	1,5
NOVA 300 M-A - SV	103002724	1X220-240 V~	0,35	0,22	0,3	1,6
NOVA 600 M-A - SV	103002744	1X220-240 V~	0,80	0,55	0,75	3,4
NOVA 600 M-NA - SV	103002754	1X220-240 V~	0,80	0,55	0,75	3,4
NOVA 600 T-NA - SV	103005814	3X400 V~	0,80	0,55	0,75	1,6

A= automatic with float NA= non automatic without float



DIMENSIONS AND WEIGHTS

NOVA 180

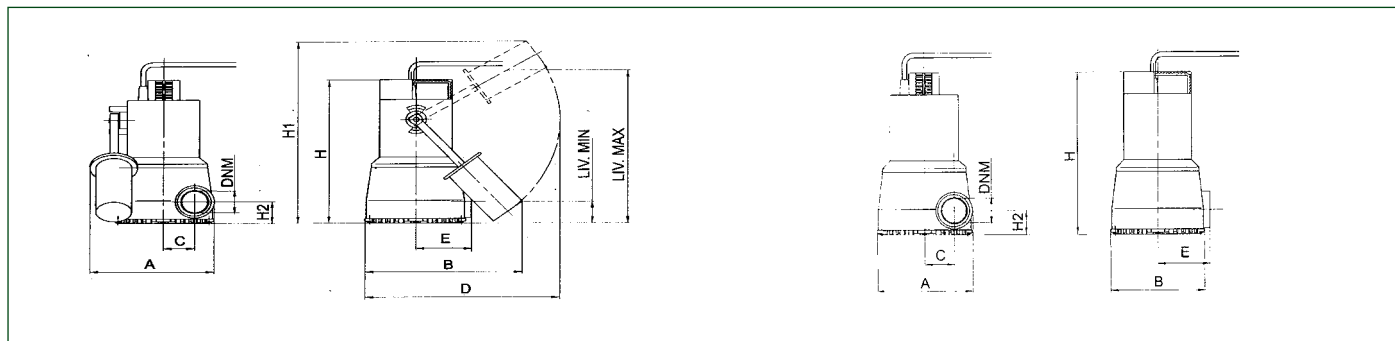

NOVA 200

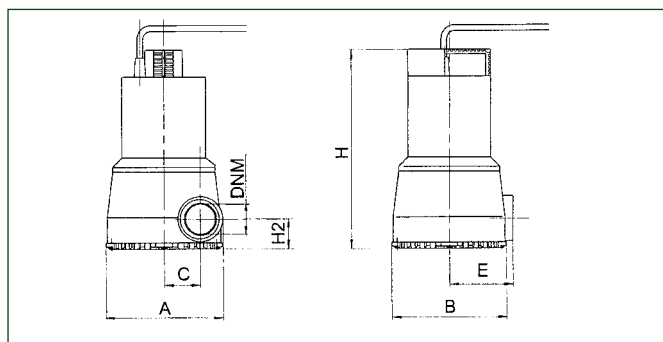

NOVA 300

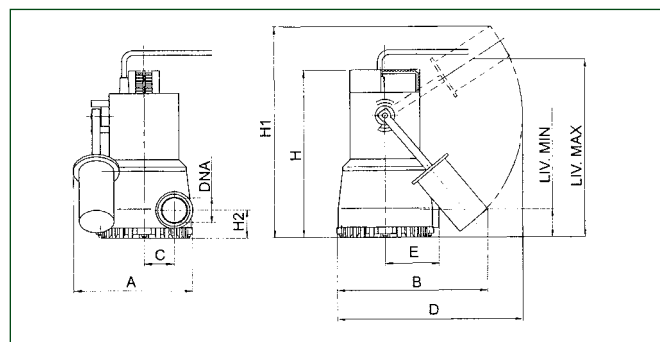

NOVA 600

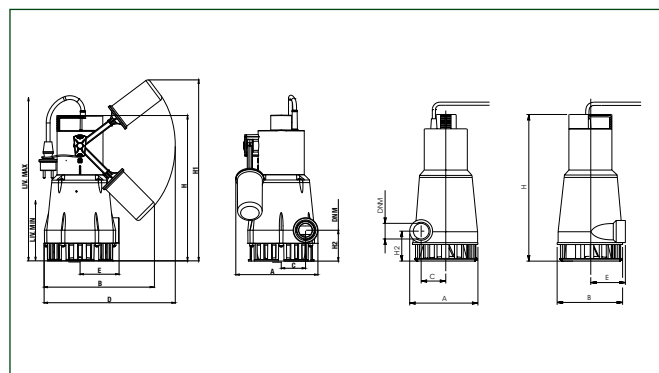

MODEL	A	B	C	D	E	H	H1	H2	LIV. MIN.	LIV. MAX	DNM GAS	PACKAGING DIMENSIONS			CABLE	Q.TY X PALLETS	WEIGHT KG
												L/A	L/B	H			
NOVA 180 M-A	181	235	46	296	82	253	345	38	77	77	1/4"	287	202	320	5 mt.	48	4,6
NOVA 180 M-NA	148	148	46	-	82	253	-	38	-	-	1/4"	287	202	320	10 mt.	48	4,5
NOVA 180 M-A SV *	181	235	46	296	82	253	345	38	77	77	1/4"	287	202	320	5 mt.	48	4,6
NOVA 180 M-NA SV *	148	148	46	-	82	253	-	38	-	-	1/4"	287	202	320	10 mt.	48	4,5
NOVA 200 M-NA	148	148	46	-	82	253	-	38	-	-	1/4"	287	202	320	10 mt.	48	4,5
NOVA 200 M-NA SV *	148	148	46	-	82	253	-	38	-	-	1/4"	287	202	320	10 mt.	48	4,5
NOVA 300 M-A	181	235	46	296	82	262	354	47	85	85	1/4"	287	202	320	5 mt.	48	4,6
NOVA 300 M-A SV *	181	235	46	296	82	262	354	47	85	85	1/4"	287	202	320	10 mt.	48	4,6
NOVA 600 M-A	193	235	56	296	90	368	443	73	190	190	1/4"	287	202	431	5 mt.	32	7
NOVA 600 (M-T)-NA	162	160	56	-	90	368	-	73	-	-	1/4"	287	202	431	10 mt.	32	6,7
NOVA 600 M-A SV *	193	235	56	296	90	368	443	73	190	190	1/4"	287	202	431	5 mt.	32	7
NOVA 600 (M-T)-NA SV *	162	160	56	-	90	368	-	73	-	-	1/4"	287	202	431	10 mt.	32	6,7

* With special stainless steel motor shaft.