

~ 2900 r.p.m. **MSV/MSH**
 ~ 1450 r.p.m. **4MSV/4MSH**

CARATTERISTICHE COSTRUTTIVE / CONSTRUCTION FEATURES
 CARACTERÍSTICAS CONSTRUCTIVAS / CARACTÉRISTIQUES D'EXECUTION

Corpo pompa	ghisa
Pump body	cast iron
Cuerpo bomba	fundición
Corps de pompe	fonte
Supporto motore	ghisa
Motor bracket	cast iron
Soporte motor	fundición
Support moteur	fonte
Girante	ottone
Impeller	brass
Rodete	latón
Turbine	laiton
Tenuta meccanica	ceramica-grafite
Mechanical seal	ceramic-graphite
Sello mecánico	cerámica-grafito
Garniture mécanique	céramique-graphite
Albero motore	acciaio AISI 304
Motor shaft	stainless steel AISI 304
Eje motor	acero AISI 304
Arbre moteur	acier AISI 304
Temperatura del liquido	
Liquid temperature	-10 ÷ +90 °C
Temperatura del líquido	
Température du liquide	
Pressione di esercizio	
Operating pressure	max 30 bar
Presión de trabajo	
Pression de fonctionnement	
MOTORE / MOTOR / MOTOR / MOTEUR	
Motore 2 e 4 poli a induzione	3~ 230/400V-50Hz 1~ 230V-50Hz
2 and 4 pole induction motor	Classe di efficienza IE3 o standard Pentax
Motor de 2 y 4 polos a inducción	IE3 efficiency class or Pentax standard
Moteur à induction à 2 et 4 pôles	Clase de eficiencia IE3 o standard Pentax Classe rendement IE3 ou Pentax standard
Classe di isolamento	
Insulation class	F
Clase de aislamiento	
Classe d'isolation	
Grado di protezione	
Protection degree	IP55
Grado de protección	
Protection	



Pompe centrifughe multistadio, verticali e orizzontali, che assicurano pressioni elevate. Particolarmente adatte per applicazioni civili ed industriali - in particolare per gruppi di pressurizzazione, impianti antincendio e impianti di lavaggio.

Multi-stage centrifugal pumps, vertical and horizontal, that guarantee high pressure. Particularly suitable for civil and industrial applications - in particular pressurisation systems, fire fighting systems and washing plant.

Bombas centrifugas multicelulares, verticales y horizontales, que garantizan presiones elevadas. Particularmente apropiadas para aplicaciones civiles e industriales - en particular para equipos de presión, instalaciones antiincendio e instalaciones de lavado.

Pompes centrifuges multicellulaires, verticales et horizontales, qui assurent des pressions élevées. Particulièrement indiquées pour les applications civiles et industrielles, spécialement pour les groupes de surpression, les installations anti-incendie et les installations de lavage.

MSV/MSH - 2900 r.p.m.

TYPE	P2		P1 kW	I(A) 3x400V									
	HP	kW			0	6	9	12	15	18	21		
						100	150	200	250	300	350		
					1,67	2,5	3,33	4,17	5	5,83			
MSVA MSHA	-3/5,5	7,5	5,5	6,8	11,8	91	84,9	81,4	76,5	69,7	62,4	54,1	
	-4/7,5	10	7,5	8,6	14,7	120,3	111,6	107,7	101	93	83,8	73,2	
	-5/9,2	12,5	9,2	10,5	18,2	154,5	143	137	129,4	119,3	108,5	97,3	
	-6/11	15	11	12,9	22,2	179	167,2	159,5	150	138	123,2	107,6	
	-8/15	20	15	17,2	28,8	240,4	227,2	219,2	206,5	191,5	171,7	147	
MSVB MSHB	-2/7,5	10	7,5	9	15,4	76,8			72,9	71,3	68,7	66,2	
	-3R/9,2	12,5	9,2	10,9	18,7	103,5			102	99,5	95,5	92	
	-3/11	15	11	12,8	22,2	116,6			111,6	109,1	106	101,5	
	-4/15	20	15	16,4	27,6	155,5			146,5	143	137,5	133	
	-5/18,5	25	18,5	21,7	35,7	195,5			181	176,8	170,8	163,7	
	-6/22	30	22	24,7	41,8	226,2			214,6	210	203	195,2	
MSVC MSHC	-2R1/11	15	11	13	22,5	80,2							
	-3R/15	20	15	18,3	31,0	113,2							
	-3/18,5	25	18,5	21,5	35,3	131,3							
	-4R1/22	30	22	25,5	43,3	162,2							
	-5/30	40	30	35,7	59,4	219							
	-6/37	50	37	43,9	72,4	261,5							
MSVD MSHD	-2/15	20	15	17,9	29,8	79,8							
	-3R/18,5	25	18,5	22,4	37,2	104							
	-3/22	30	22	24,9	42,4	119,2							
	-4/30	40	30	33,7	55,8	155,5							
	-5/37	50	37	41,9	69,6	197,5							

Q (m³/h - l/min - l/s)																
	24	27	30	33	36	39	42	48	54	57	60	66	72	78	84	90
	400	450	500	550	600	650	700	800	900	950	1000	1100	1200	1300	1400	1500
	6,67	7,5	8,33	9,17	10	10,83	11,67	13,33	15	15,83	16,67	18,33	20	21,67	23,33	25
H (m)																
	44,7	34,3														
	62,1	49,7														
	83,8	68,2														
	87,4															
	118,4															
	63	57,6	54,1	49,5	44,5	38,9										
	85,4	78,8	70,7	62,1	53,6	44,5										
	96	89,9	83,8	76	67,7	57,8										
	125,8	118	110	100,5	91	81,8										
	155,5	147,5	137,7	126,3	114,1	102										
	185,3	174,7	162,6	149,5	135,3	120,2										
	76,8	74,8	73,2	71	68,6	65,6	62,6	55,2	46,4	40,4						
	109	106	102,8	98,5	94,1	89,9	85,1	72,8	59,3	50,6						
	126	122,7	119,2	115,6	111,3	107	102	90,9	79,7	72,5	63,8					
	157,5	153,7	150,3	145,3	139,7	134,1	128,3	117,4	98,8	89,7	79,3					
	208,5	204,5	200	194,5	188,4	181,3	173,7	155,5	135,8	125,2	111,3					
	252	246,5	239,4	233	225	217,8	209	189,6	165,5	151	134,8					
					78	77	75,7	73,4	69,9	67,9	66	61,6	56,7	51,3	45,2	38,4
					101,5	99,5	97,8	93,2	88,4	85,8	82,8	76,7	69,7	62,6	53,8	44,7
					116	114	112	107,4	102,2	99,2	95,6	88,9	81,2	73,5	65,6	56,1
					152,7	150,5	147,6	141,4	134,3	130,3	126,3	116,7	107	97,2	85,8	73,2
					188	185	181	173,8	164,4	159	154	143,4	132	119,5	106	90,9

B

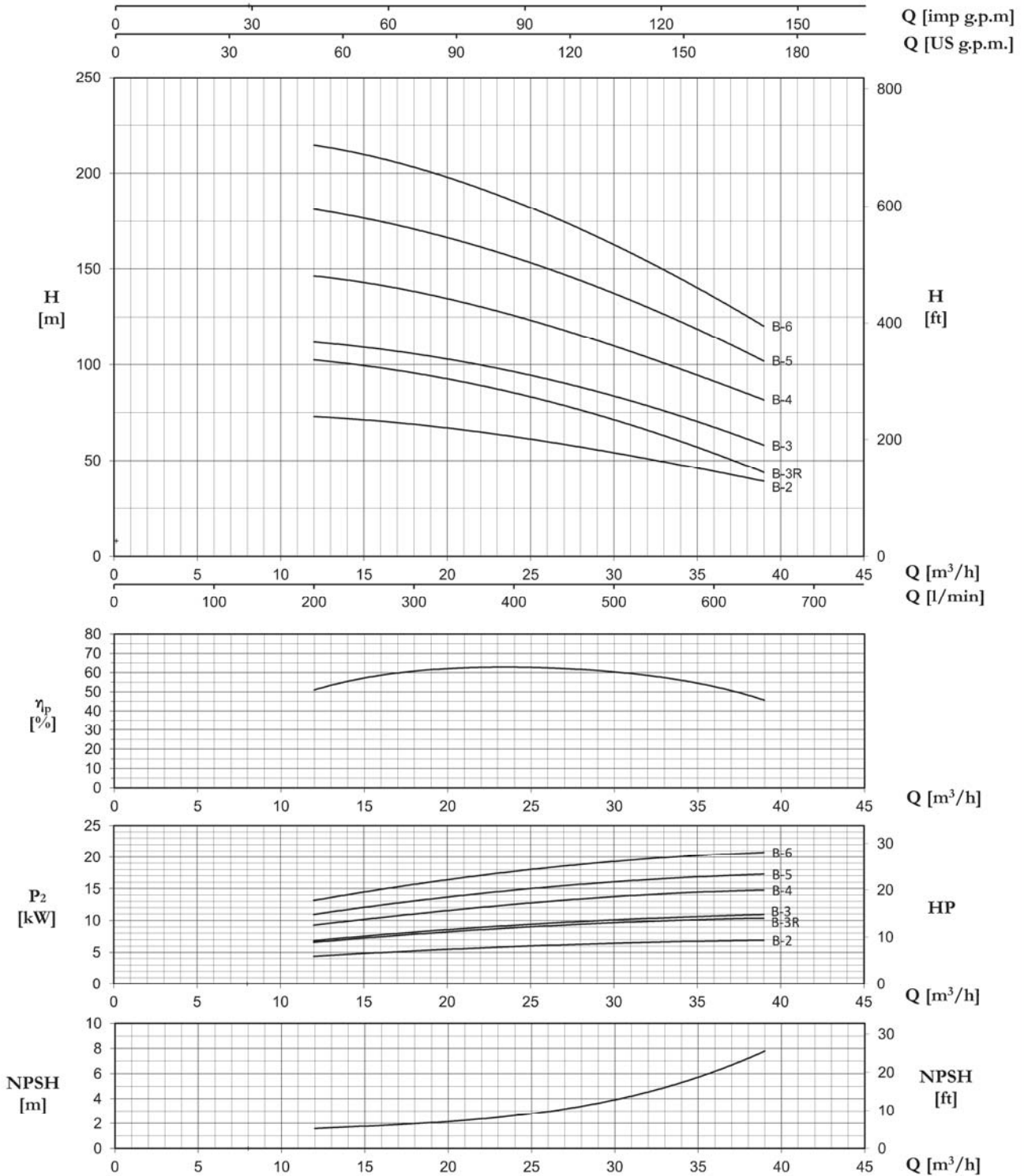

TYPE	P2		P1 kW	I(A) 3x400V	Q (m³/h - l/min - l/s)											
	HP	kW			0	12	15	18	21	24	27	30	33	36	39	
						200	250	300	350	400	450	500	550	600	650	
					3,33	4,17	5	5,83	6,67	7,5	8,33	9,17	10	10,83		
					H (m)											
MSVB MSHB	-2/7,5	10	7,5	9	15,4	76,8	72,9	71,3	68,7	66,2	63	57,6	54,1	49,5	44,5	38,9
	-3R/9,2	12,5	9,2	10,9	18,7	103,5	102	99,5	95,5	92	85,4	78,8	70,7	62,1	53,6	44,5
	-3/11	15	11	12,8	22,2	116,6	111,6	109,1	106	101,5	96	89,9	83,8	76	67,7	57,8
	-4/15	20	15	16,4	27,6	155,5	146,5	143	137,5	133	125,8	118	110	100,5	91	81,8
	-5/18,5	25	18,5	21,7	35,7	195,5	181	176,8	170,8	163,7	155,5	147,5	137,7	126,3	114,1	102
-6/22	30	22	24,7	41,8	226,2	214,6	210	203	195,2	185,3	174,7	162,6	149,5	135,3	120,2	

MSV - 2900 r.p.m.
4MSV - 1450 r.p.m.

TYPE: VB-2/7.5
 VC-2R1/11
 VD-2/15
 4VD-2/2.2

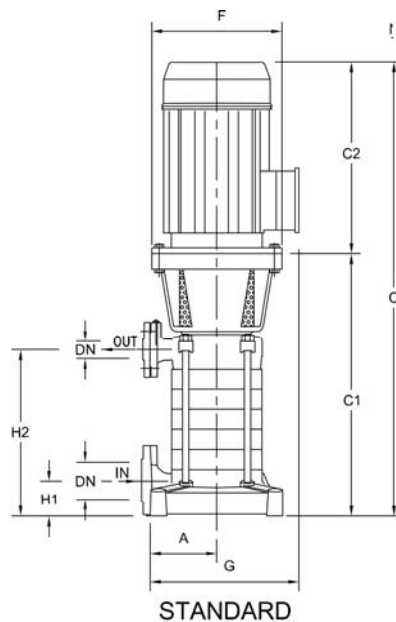
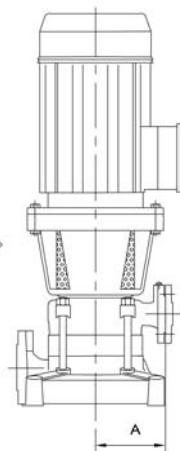
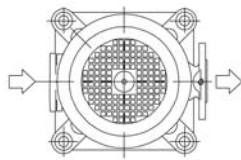

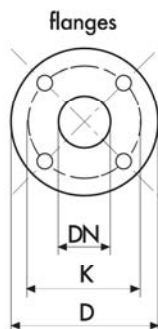
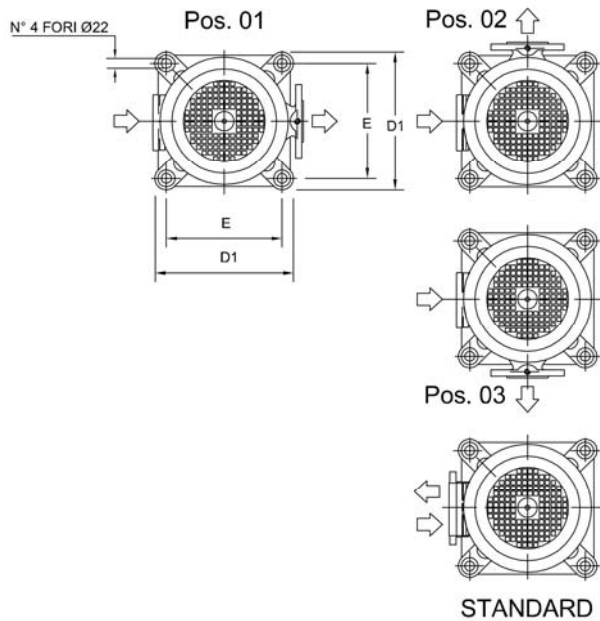

Orientamento bocche
 Direction of nozzles
 Orientación bocas
 Orientación bridas



DIMENSIONS (mm)				
DN	D	K	holes	
			n°	Ø
40	150	110	4	18
50	165	125	4	18
65	185	145	4	18
80	200	160	8	18

- 2900 r.p.m. MSV

TYPE	DN IN	DN OUT	N. STAGE	DIMENSIONS (mm)																	
				A	C	C IE3	C1	C2	C2 IE3	D1	E	F	G	H1	H2	I	L	M	Std.	IE3	
MSVA -3/5.5	(UNI PN 16) 50 (UNI PN 40) 40		3	175	921,5	947,5	544,5	377	403	306	256	300	355	82	255,5	1100	400	500	134	137	
MSVA -4/7.5			4		972,5	1025,5	595,5	377	430			300	355		306,5	1100	400	500	155	153	
MSVA -5/9.2			5		1062,5	-	646,5	416	-			300	355		357,5	1100	400	500	171	229	
MSVA -6/11			6		1113,5	1202,5	697,5	416	505			300	355		408,5	1100	400	500	189	239	
MSVA -8/15			8		1297,5	1289,5	799,5	498	490			350	410		510,5	1400	500	500	259	283	
MSVB -2/7.5	(UNI PN 16) 50 (UNI PN 40) 40		2	175	870,5	923,5	493,5	377	430	306	256	300	355	82	204,5	1100	400	500	135	133	
MSVB -3R/9.2			3		931	-	515	416	-			300	335		255,5	1100	400	500	150	207	
MSVB -3/11			3		931	1020	515	416	505			300	355		255,5	1100	400	500	160	208	
MSVB -4/15			4		1013	1005	515	498	490			350	410		306,5	1400	500	500	192	236	
MSVB -5/18.5			5		1056	1045	515	541	530			350	410		357,5	1400	500	500	219	271	
MSVB -6/22			6		1056	1095	515	541	580			350	410		408,5	1400	500	500	238	316	
MSVC -2R1/11	(UNI PN 16) 65 (UNI PN 40) 50		2	200	944	1033	528	416	505	332	282	300	380	95	233	1100	400	500	175	217	
MSVC -3R/15			3		1086	1078	588	498	490			350	435		293	1100	400	500	208	259	
MSVC -3/18.5			3		1129	1118	588	541	530			350	435		293	1400	500	500	227	277	
MSVC -4R1/22			4		1189	1228	648	541	580			350	435		353	1400	500	500	247	327	
MSVC -5/30			5		1276	1358	708	568	650			350	450		413	1400	500	500	330	392	
MSVC -6/37			6		1336	1418	768	568	650			350	450		473	1400	500	500	369	426	
MSVD -2/15	(UNI PN 16) 65 (UNI PN 40) 50		2	200	1026	1018	528	498	490	332	282	350	435	95	233	1400	400	500	175	235	
MSVD -3R/18.5			3		1129	1118	588	541	530			350	435		293	1400	500	500	208	276	
MSVD -3/22			3		1129	1168	588	541	580			350	435		293	1400	500	500	227	312	
MSVD -4/30			4		1216	1298	648	568	650			350	450		353	1400	500	500	247	379	
MSVD -5/37			5		1276	1358	708	568	650			350	450		413	1400	500	500	330	410	

- 1450 r.p.m. 4MSV

TYPE	DN IN	DN OUT	N. STAGE	DIMENSIONS (mm)																Kg
				A	C (IE3)	C1	C2 (IE3)	D1	E	F	G	H1	H2	I	L	M				
4MSVA -8/2,2	(UNI PN 16) 50 (UNI PN 40) 40		8	175	1078	762,5	315	306	256	250	345	82	510,5	1100	400	500	183			
4MSVB -4/2,2	(UNI PN 16) 50 (UNI PN 40) 40		4	175	874	558,5	315	306	256	250	345	82	306,5	1100	400	500	136			
4MSVB -5/2,2			5		925	609,5	315			250	345		357,5	1400	500	500	140			
4MSVB -6/3			6		976	660,5	315			250	345		408,5	1400	500	500	171			
4MSVB -8/4			8		1103	762,5	340			250	368		511	1400	500	500	200			
4MSVC -3/2,2	(UNI PN 16) 65 (UNI PN 40) 50		3	200	866	551	315	332	282	250	370	95	293	1100	400	500	192			
4MSVC -4/3			4		926	611	315			250	370		353	1100	400	500	194			
4MSVC -5/4			5		1011	671	340			250	393		413	1100	400	500	202			
4MSVC -6/5,5			6		1116	731	385			300	423		473	1400	500	500	206			
4MSVD -2/2,2	(UNI PN 16) 65 (UNI PN 40) 50		2	200	806	491	315	332	282	250	370	95	233	1100	400	500	135			
4MSVD -3/3			3		866	551	315			250	370		293	1100	400	500	167			
4MSVD -4/4			4		951	611	340			250	393		353	1100	400	500	189			
4MSVD -5/5,5			5		1056	671	385			300	423		413	1100	400	500	194			
4MSVD -6/7,5			6		1156	731	425			300	423		473	1400	500	500	218			

MSH - 2900 r.p.m.
4MSH - 1450 r.p.m.

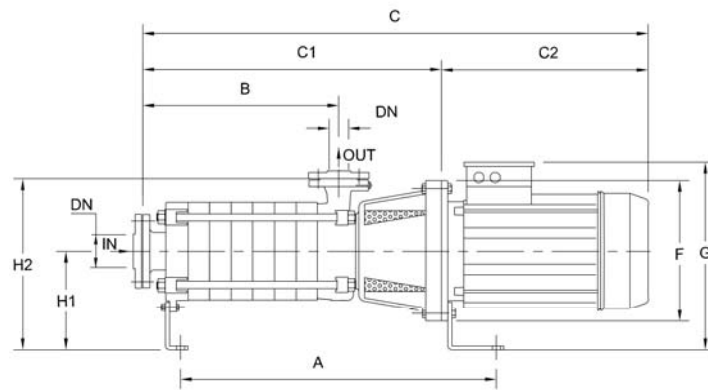

STANDARD

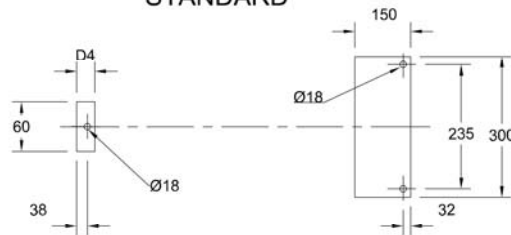

Orientamento bocche
Direction of nozzles
Orientación bocas
Orientation brides

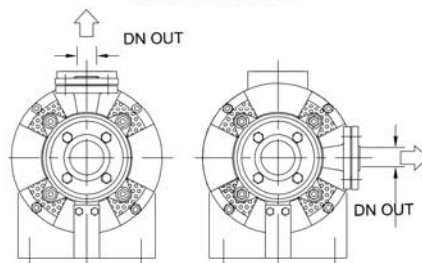

STANDARD

Pos. 01

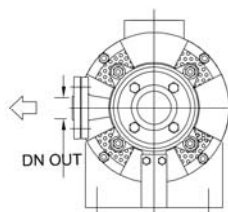

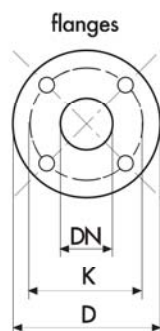

Pos. 02





DIMENSIONS (mm)				
DN	D	K	holes	
			n°	Ø
40	150	110	4	18
50	165	125	4	18
65	185	145	4	18
80	200	160	8	18

- 2900 r.p.m. MSH

TYPE	DN IN	DN OUT	N. STAGE	DIMENSIONS (mm)																
				A	B	C	C IE3	C1	C2	C2 IE3	F	G	H1	H2	D4	I	L	M	Std.	IE3
MSHA -3/5.5	(UNI PN 16) 65	(UNI PN 40) 40	3	604	256,5	922,5	948,5	545,5	377	403	300	425	245	420	70	1100	400	500	135	138
MSHA -4/7.5			4	655	307,5	973,5	1026,5	596,5	377	430	300	425				1100	400	500	156	154
MSHA -5/9.2			5	706	358,5	1063,5	-	647,5	416	-	300	425				1100	400	500	172	230
MSHA -6/11			6	757	409,5	1114,5	1203,5	698,5	416	505	300	425				1100	400	500	190	240
MSHA -8/15			8	859	511,5	1298,5	800,5	800,5	498	-	350	480				1400	500	500	259	283
MSHB -2/7.5	(UNI PN 16) 65	(UNI PN 40) 40	2	553	205,5	531,5	924,5	494,5	37	430	300	425	245	420	70	1100	400	500	135	134
MSHB -3R/9.2			3	604	256,5	961,5	-	545,5	416	-	300	425				1100	400	500	151	208
MSHB -3/11			3	604	256,5	961,5	1050,5	545,5	416	505	300	425				1100	400	500	161	209
MSHB -4/15			4	655	307,5	1094,5	1086,5	596,5	498	490	350	480				1400	500	500	220	244
MSHB -5/18.5			5	706	358,5	1188,5	1177,5	647,5	541	530	350	480				1400	500	500	244	271
MSHB -6/22			6	757	409,5	1239,5	1278,5	698,5	541	580	350	480				1400	500	500	262	316
MSHC -2R1/11	(UNI PN 16) 80	(UNI PN 40) 50	2	596	243	954	1043	538	416	505	300	425	245	445	60	1100	400	500	177	215
MSHC -3R/15			3	656	303	1096	1088	598	498	490	350	480				1100	400	500	211	251
MSHC -3/18.5			3	656	303	1139	1128	598	541	530	350	480				1400	500	500	248	275
MSHC -4R1/22			4	716	363	1199	1238	658	541	580	350	480				1400	500	500	271	325
MSHC -5/30			5	776	423	1286	1368	718	568	650	350	495				1400	500	500	333	390
MSHC -6/37			6	836	483	1346	1428	778	568	650	350	495				1400	500	500	373	424
MSHD -2/15	(UNI PN 10) 80	(UNI PN 40) 50	2	596	243	1036	1028	538	498	490	350	480	245	445	60	1400	400	500	201	233
MSHD -3R/18.5			3	656	303	1139	1128	598	541	530	350	480				1400	500	500	230	274
MSHD -3/22			3	656	303	1139	1178	598	541	580	350	480				1400	500	500	241	309
MSHD -4/30			4	716	363	1226	1308	658	568	650	350	495				1400	500	500	324	377
MSHD -5/37			5	776	423	1286	1368	718	568	650	350	495				1400	500	500	363	408

- 1450 r.p.m. 4MSH

TYPE	DN IN	DN OUT	N. STAGE	DIMENSIONS (mm)														
				A	B	C (IE3)	C1	C2 (IE3)	F	G	H1	H2	D4	I	L	M		
4MSHA -8/2,2	(UNI PN 16) 65	(UNI PN 40) 40	8	822	511,5	1079	763,5	315	250	415	245	420	70	1100	400	500	183	
4MSHB -4/2,2	(UNI PN 16) 65	(UNI PN 40) 40	4	618	511,5	875	559,5	315	250	415	245	420	70	1100	400	500	136	
4MSHB -5/2,2			5	670	307,5	926	610,5	315	250	415				1400	500	500	140	
4MSHB -6/3			6	720	358,5	977	661,5	315	250	415				1400	500	500	171	
4MSHB -8/4			8	720	409,5	1104	763,5	340	250	438				1400	500	500	200	
4MSHC -3/2,2	(UNI PN 16) 80	(UNI PN 40) 50	3	620	303	876	561	315	250	415	245	445	60	1100	400	500	192	
4MSHC -4/3			4	680	363	936	621	315	250	415				1100	400	500	194	
4MSHC -5/4			5	740	423	1021	681	340	250	438				1100	400	500	202	
4MSHC -6/5,5			6	800	483	1126	741	385	300	468				1400	500	500	206	
4MSHD -2/2,2	(UNI PN 10) 80	(UNI PN 40) 50	2	560	243	816	501	315	250	415	245	445	60	1100	400	500	135	
4MSHD -3/3			3	620	303	876	561	315	250	415				1100	400	500	167	
4MSHD -4/4			4	680	363	961	621	340	250	438				1100	400	500	189	
4MSHD -5/5,5			5	740	423	1066	681	385	300	468				1100	400	500	194	
4MSHD -6/7,5			6	887	483	1166	741	425	300	468				1400	500	500	218	