

3D SERIES

NORMALISED AND MONOBLOCK CENTRIFUGAL ELECTROPUMPS CONFORMING TO EN 733 (EX DIN 24255)



Cast iron monoblock (3D) and normalised centrifugal electropumps conforming to EN 733 (3DS-3DP).



APPLICATIONS

- Handling of water and clean, chemically non-aggressive liquids
- Water supply
- Pressurisation
- Washing and industrial plants
- Water circulation in climate control systems
- Irrigation and agriculture

TECHNICAL FEATURES

- Highly robust construction
- Stainless steel impeller
- High efficiency

PUMP SPECIFICATIONS

- Maximum operating pressure: 10 bar
- Temperature of the liquid:
 - 5°C – +90°C
 - 5°C – +110°C (versions H-HS-HW-HSW)
 - 5°C – +120°C (version E)
- MEI > 0.4

For further information, please consult our Data Books on the website www.ebaraurope.com

MOTOR SPECIFICATIONS

- IE2 high energy-efficiency motors: from 1.1kW up to 5.5 kW for 3D4
- IE3 high energy-efficiency motors: from 7.5kW up to 22kW for 3D series
from 1.1kW up to 22kW for 3DS 3DP series
from 0.75kW to 3kW for 3DS4 3DP4
- Self-ventilated 2-pole and 4-pole motors
- Isolation class F (B for high temperatures)
- Protection rating IP 55
- Single-phase voltage 230V ±10%, 50Hz, three-phase voltage 230/400 ±10% (up to 4kW included) 50Hz, three-phase voltage 400/690V ±10% (from 5.5 kW and above) 50Hz
- Protection to be arranged by the user

Available in 3 different versions with 2-pole and 4-pole motors

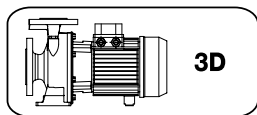

3D Monoblock with extended motor shaft

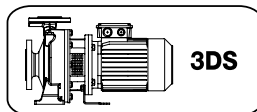

3DS Monoblock with standard motor and rigid joint

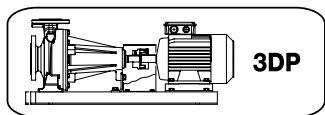

3DP On base, with standard motor and elastic joint

3DPF version (only hydraulic part) available on request

MATERIALS

- Cast iron pump body EN-GJL-250-EN 1561
- Impeller made of:
 - AISI 304 steel for SERIES 3D 32, 40, 50
 - AISI 316 microcast steel for SERIES 3D 65
- AISI 304 steel shaft (part coming into contact with liquid)
- Mechanical seal made of:
 - Ceramic/Carbon/NBR (standard)
 - Ceramic/Carbon/FPM (version H)
 - SiC/SiC/FPM (version HS)
 - Tungsten carbide/Tungsten carbide/FPM (version HW)
 - SiC/Tungsten carbide/FPM (version HSW)
 - Ceramic/Carbon/EPDM (version E)

SPECIAL VERSIONS

- Special voltages
- Special mechanical seals



3D SERIES

NORMALISED AND MONOBLOCK CENTRIFUGAL ELECTROPUMPS CONFORMING TO EN 733 (EX DIN 24255)

IDENTIFICATION CODE

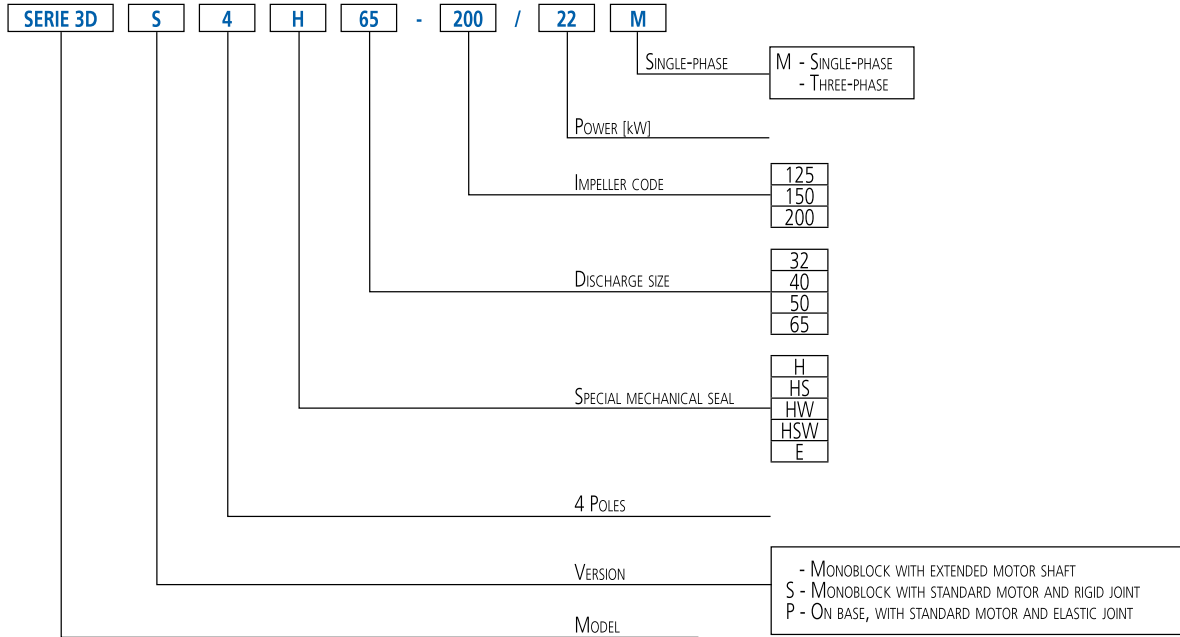

The contents of this publication must not be regarded as binding. EBARA Pumps Europe S.p.A. reserves the right to effect any modifications it deems necessary, without prior notice.



3D SERIES

NORMALISED AND MONOBLOCK CENTRIFUGAL ELECTROPUMPS CONFORMING TO EN 733 (EX DIN 24255)

PERFORMANCE RANGE at 2900 min⁻¹ (according to ISO 9906 Attachment A)

2 Poles

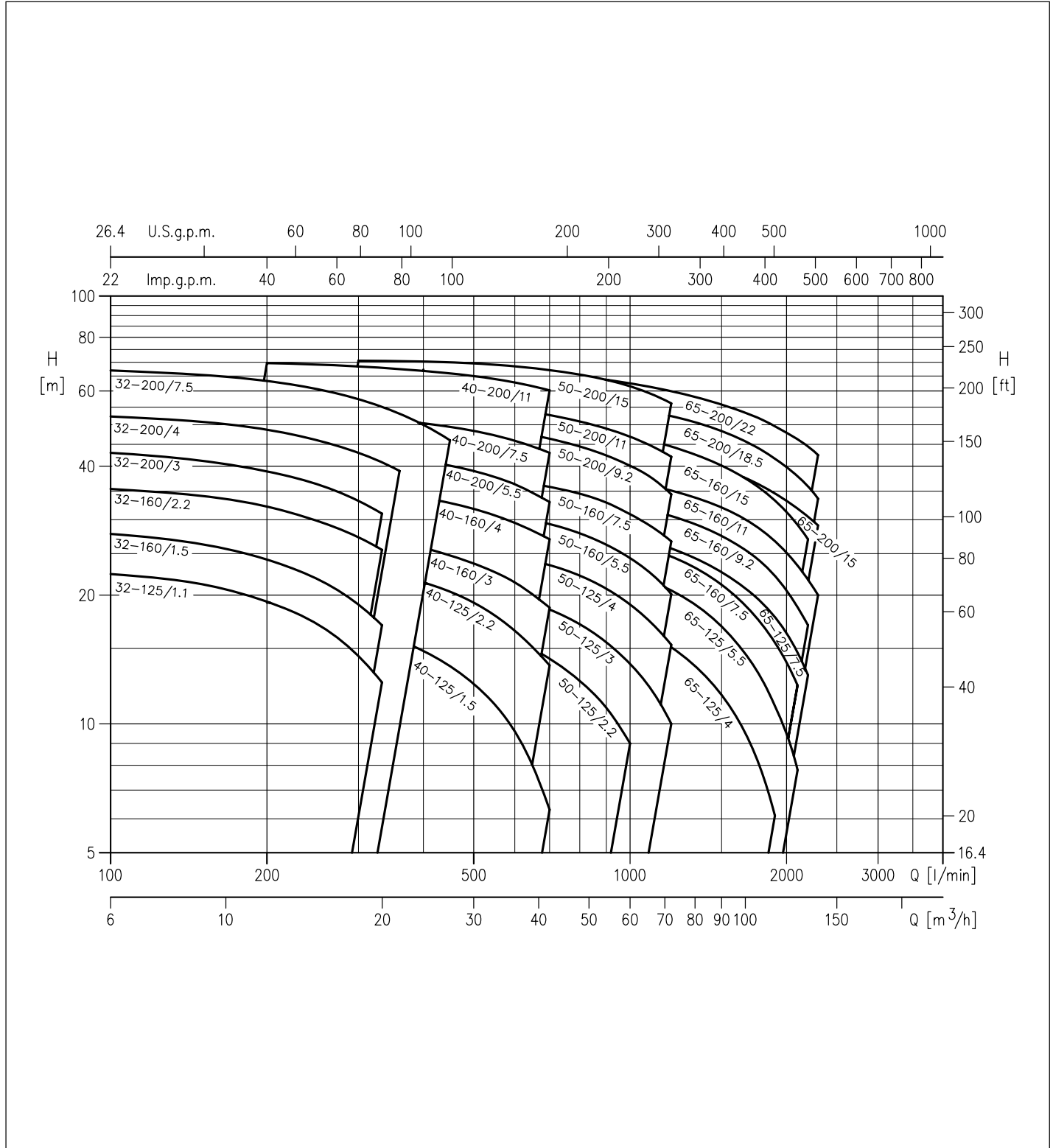

The contents of this publication must not be regarded as binding. EBARA Pumps Europe S.p.A. reserves the right to effect any modification it deems necessary, without prior notice.

3D SERIES

NORMALISED AND MONOBLOCK CENTRIFUGAL ELECTROPUMPS CONFORMING TO EN 733 (EX DIN 24255)

SERIES 3D(.) 32 PERFORMANCE TABLE

2 Poles

Model	P ₂		Q=Flow rate									
	[HP]	[kW]	l/min m ³ /h	100 6	150 9	200 12	250 15	300 18	333 20	360 21,6	400 24	450 27
			H=Head [m]									
3D(.) 32-125/1.1 (M)	1,5	1,1	22,4	21,2	19,3	17,1	14,4	12,5	-	-	-	-
3D(.) 32-160/1.5 (M)	2	1,5	27,5	25,9	23,7	21,3	18,5	16,4	-	-	-	-
3D(.) 32-160/2.2 (M)	3	2,2	35,4	34,1	32,2	29,8	27,3	25,5	-	-	-	-
3D(.) 32-200/3.0	4	3	43,0	41,0	39,0	36,5	33,0	31,0	-	-	-	-
3D(.) 32-200/4.0	5,5	4	52,5	51,0	49,0	46,0	43,0	41,0	39,0	-	-	-
3D(.) 32-200/7.5	10	7,5	67,0	65,0	63,0	61,0	57,0	55,0	53,0	50,0	46,0	-

SERIES 3D(.) 40 PERFORMANCE TABLE

2 Poles

Model	P ₂		Q=Flow rate									
	[HP]	[kW]	l/min m ³ /h	200 12	250 15	300 18	350 21	400 24	450 27	500 30	600 36	700 42
			H=Head [m]									
3D(.) 40-125/1.5 (M)	2	1,5	18,2	17,6	16,8	15,9	14,8	13,7	12,4	9,6	6,3	-
3D(.) 40-125/2.2 (M)	3	2,2	24,4	23,9	23,2	22,4	21,4	20,4	19,2	16,5	13,7	-
3D(.) 40-160/3.0	4	3	29,4	28,7	27,8	26,8	25,8	24,8	23,7	21,4	18,7	-
3D(.) 40-160/4.0	5,5	4	37,2	36,5	35,7	34,8	33,8	32,8	31,8	29,5	27,0	-
3D(.) 40-200/5.5	7,5	5,5	44,5	44,0	43,0	42,0	41,0	40,0	39,0	36,3	33,0	-
3D(.) 40-200/7.5	10	7,5	53,5	53,0	52,0	51,5	50,5	49,5	48,5	46,0	43,0	-
3D(.) 40-200/11	15	11	70,0	69,0	68,5	67,5	67,0	66,0	65,0	63,0	60,0	-

SERIES 3D(.) 50 PERFORMANCE TABLE

2 Poles

Model	P ₂		Q=Flow rate									
	[HP]	[kW]	l/min m ³ /h	400 24	500 30	600 36	700 42	800 48	900 54	1000 60	1100 66	1200 72
			H=Head [m]									
3D(.) 50-125/2.2 (M)	3	2,2	18,0	17,0	15,7	14,2	12,6	10,9	9,0	-	-	-
3D(.) 50-125/3.0	4	3	21,5	20,8	19,8	18,5	17,1	15,5	13,8	12,0	10,0	-
3D(.) 50-125/4.0	5,5	4	25,8	25,3	24,5	23,5	22,2	20,7	19,0	17,2	15,3	-
3D(.) 50-160/5.5	7,5	5,5	32,0	31,5	30,5	29,3	27,9	26,2	24,4	22,4	20,0	-
3D(.) 50-160/7.5	10	7,5	38,2	37,6	36,9	35,8	34,5	32,9	30,9	28,9	26,7	-
3D(.) 50-200/9.2	12,5	9,2	-	49,5	48,0	46,5	44,5	42,5	40,0	37,6	34,4	-
3D(.) 50-200/11	15	11	-	55,5	54,5	52,5	51,0	49,0	47,0	44,5	42,0	-
3D(.) 50-200/15	20	15	-	69,5	68,5	67,0	65,5	63,5	61,5	59,0	56,0	-

SERIES 3D(.) 65 PERFORMANCE TABLE

2 Poles

Model	P ₂		Q=Flow rate									
	[HP]	[kW]	l/min m ³ /h	600 36	700 42	1000 60	1300 78	1600 96	1900 114	2100 126	2200 132	2300 138
			H=Head [m]									
3D(.) 65-125/4.0	5,5	4	20,4	19,8	17,2	14,0	10,4	6,0	-	-	-	-
3D(.) 65-125/5.5	7,5	5,5	-	25,0	22,5	19,4	15,5	11,0	8,0	-	-	-
3D(.) 65-125/7.5	10	7,5	-	29,6	27,5	24,7	21,5	17,8	14,7	13,0	-	-
3D(.) 65-160/7.5	10	7,5	-	29,0	26,6	23,5	19,8	15,5	12,3	-	-	-
3D(.) 65-160/9.2	12,5	9,2	-	34,7	32,4	29,6	26,3	22,2	18,8	17,0	-	-
3D(.) 65-160/11	15	11	-	39,0	37,0	34,0	31,0	27,0	23,0	22,0	20,0	-
3D(.) 65-160/15	20	15	-	46,0	44,0	41,5	38,4	34,6	31,9	30,5	29,0	-
3D(.) 65-200/15	20	15	-	51,0	47,0	43,0	38,6	33,3	29,2	27,0	-	-
3D(.) 65-200/18.5	25	18,5	-	58,0	55,0	51,0	47,0	41,5	37,9	35,9	33,6	-
3D(.) 65-200/22	30	22	-	65,5	62,5	58,5	54,5	49,5	46,0	44,5	42,5	-

(M) Single-phase version only for 3D SERIES



3D SERIES

NORMALISED AND MONOBLOCK CENTRIFUGAL ELECTROPUMPS CONFORMING TO EN 733 (EX DIN 24255)

PERFORMANCE CURVES 3D(.) 50-160 series at 2900 min⁻¹ (according to ISO 9906 Attachment A)

2 Poles

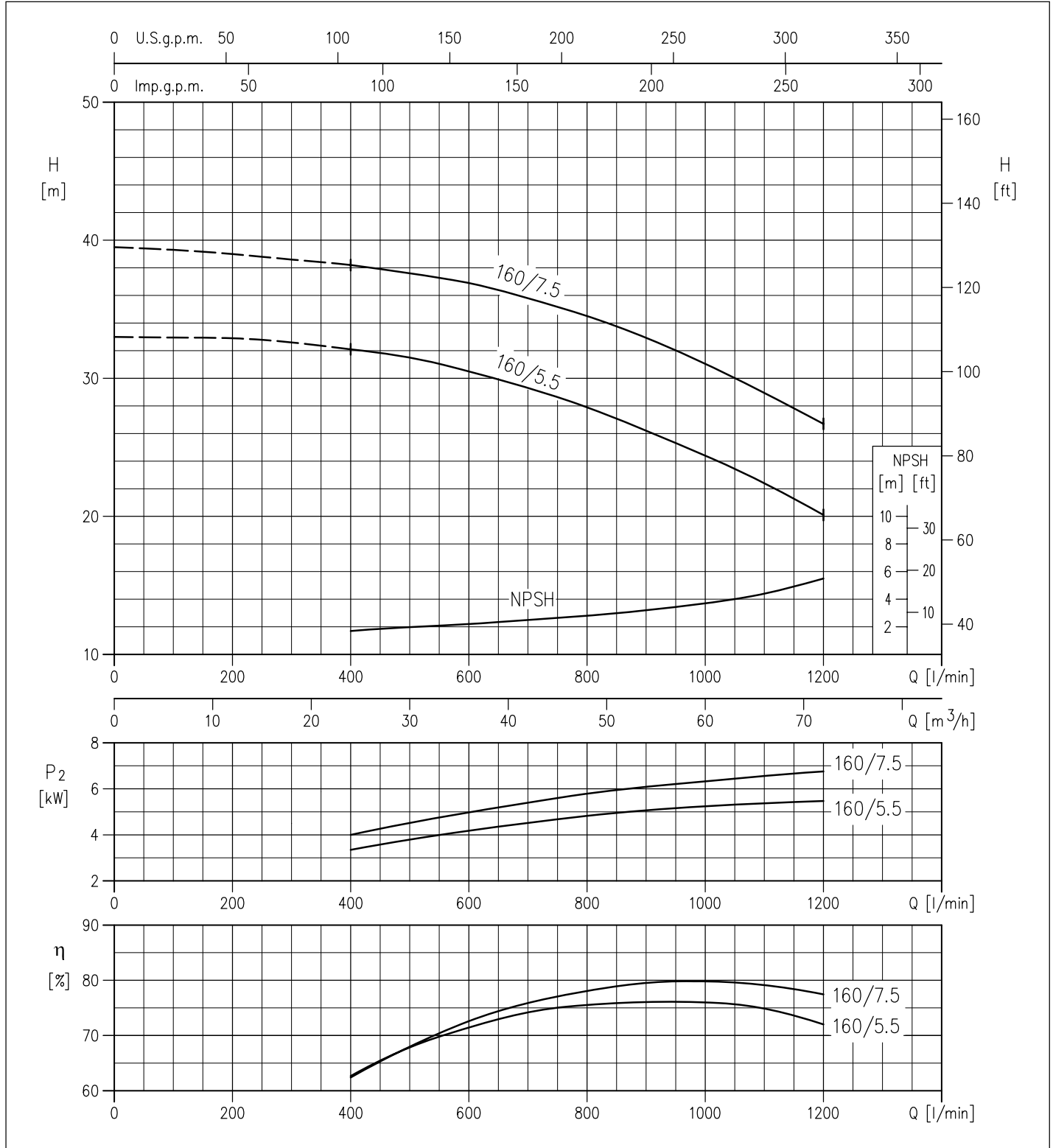

The contents of this publication must not be regarded as binding. EBARA Pumps Europe S.p.A. reserves the right to effect any modification. Changes necessary, without prior notice.

3D SERIES

NORMALISED AND MONOBLOCK CENTRIFUGAL ELECTROPUMPS
CONFORMING TO EN 733 (EX DIN 24255)

DIMENSIONS 3D SERIES - up to 11kW

2 Poles

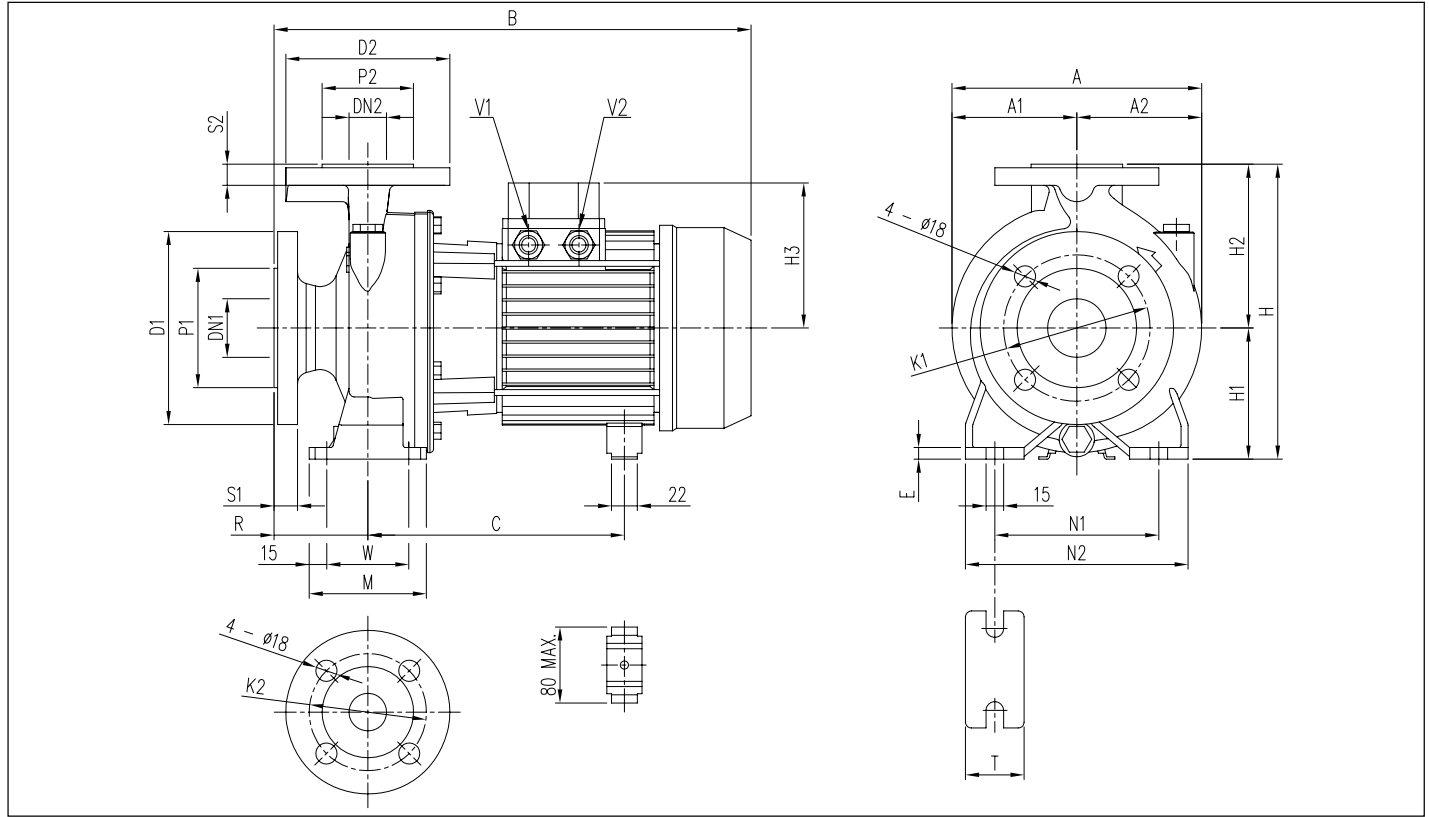

DIMENSIONAL TABLE

Model	Dimensions [mm]																				Weight [kg]															
	DN1 Ø	P1 Ø	K1 Ø	D1 Ø	S1 Ø	DN2 Ø	P2 Ø	K2 Ø	D2 Ø	S2 Ø	H	H1	H2	H3 [2]	[1]	R	W	M	N1	N2	T	E	A	A1	A2	B [2]	[1]	[*]	C [2]	[1]	V1 [1]	[2]	V2 [1]	[2]	[1]	[*]
3D 32-125/1.1(M)	50	102	125	165	20	32	78	100	140	18	252	112	140	141	124	80	70	100	140	190	50	10	213	106,5	106,5	408	407	-	219÷230	219÷230	-	M20x1,5	PG13,5	25,0	29,5	-
3D 32-160/1.5(M)	50	102	125	165	20	32	78	100	140	18	292	132	160	141	124	80	70	100	190	240	50	10	254	127	127	408	407	-	219÷230	219÷230	-	M20x1,5	PG13,5	29,0	33,5	-
3D 32-160/2.2(M)	50	102	125	165	20	32	78	100	140	18	292	132	160	141	124	80	70	100	190	240	50	10	254	127	127	408	432	-	219÷230	244÷255	-	M20x1,5	PG13,5	35,7	36,0	-
3D 32-200/3.0	50	102	125	165	20	32	78	100	140	18	340	160	180	-	124	80	70	100	190	240	50	10	296	148	148	-	471	-	-	244÷255	-	-	PG13,5	-	47,5	-
3D 32-200/4.0	50	102	125	165	20	32	78	100	140	18	340	160	180	-	141	80	70	100	190	240	50	10	296	148	148	-	494	-	-	253	-	-	PG16	-	50,0	-
3D 32-200/7.5	50	102	125	165	20	32	78	100	140	18	340	160	180	-	150	80	70	100	190	240	50	10	296	148	148	-	519	539	-	275	PG13,5	-	PG16	-	-	65,1
3D 40-125/1.5(M)	65	122	145	185	20	40	88	110	150	18	252	112	140	141	124	80	70	100	160	210	50	10	220	108	112	408	407	-	219÷230	219÷230	-	M20x1,5	PG13,5	25,5	30,0	-
3D 40-125/2.2(M)	65	122	145	185	20	40	88	110	150	18	252	112	140	141	124	80	70	100	160	210	50	10	220	108	112	408	432	-	219÷230	244÷255	-	M20x1,5	PG13,5	31,7	32,0	-
3D 40-160/3.0	65	122	145	185	20	40	88	110	150	18	292	132	160	-	124	80	70	100	190	240	50	10	254	127	127	-	471	-	-	244÷255	-	-	PG13,5	-	39,0	-
3D 40-160/4.0	65	122	145	185	20	40	88	110	150	18	292	132	160	-	141	80	70	100	190	240	50	10	254	127	127	-	494	-	-	253	-	-	PG16	-	48,0	-
3D 40-200/5.5	65	122	145	185	20	40	88	110	150	18	340	160	180	-	150	100	70	100	212	265	50	10	296	148	148	-	539	-	-	275	PG13,5	-	PG16	-	60,0	-
3D 40-200/7.5	65	122	145	185	20	40	88	110	150	18	340	160	180	-	150	100	70	100	212	265	50	10	296	148	148	-	539	559	-	275	PG13,5	-	PG16	-	-	66,1
3D 40-200/11	65	122	145	185	20	40	88	110	150	18	340	160	180	-	178	100	70	100	212	265	50	10	296	148	148	-	595	-	-	359	PG13,5	-	PG21	-	-	82,4
3D 50-125/2.2(M)	65	122	145	185	20	50	102	125	165	20	292	132	160	141	124	100	70	100	190	240	50	10	254	127	127	428	452	-	219÷230	244÷255	-	M20x1,5	PG13,5	34,4	37,0	-
3D 50-125/3.0	65	122	145	185	20	50	102	125	165	20	292	132	160	-	124	100	70	100	190	240	50	10	254	127	127	-	491	-	-	244÷255	-	-	PG13,5	-	39,5	-
3D 50-125/4.0	65	122	145	185	20	50	102	125	165	20	292	132	160	-	141	100	70	100	190	240	50	10	254	127	127	-	514	-	-	253	-	-	PG16	-	48,0	-
3D 50-160/5.5	65	122	145	185	20	50	102	125	165	20	340	160	180	-	150	100	70	100	212	265	50	10	296	148	148	-	539	-	-	275	PG13,5	-	PG16	-	60,0	-
3D 50-160/7.5	65	122	145	185	20	50	102	125	165	20	340	160	180	-	150	100	70	100	212	265	50	10	296	148	148	-	539	559	-	275	PG13,5	-	PG16	-	-	67,1
3D 50-200/9.2	65	122	145	185	20	50	102	125	165	20	360	160	200	-	178	100	70	100	212	265	50	10	296	148	148	-	595	-	-	359	PG13,5	-	PG21	-	-	77,0
3D 50-200/11	65	122	145	185	20	50	102	125	165	20	360	160	200	-	178	100	70	100	212	265	50	10	296	148	148	-	595	-	-	359	PG13,5	-	PG21	-	-	82,4
3D 65-125/4.0	80	138	160	200	22	65	122	145	185	20	340	160	180	-	141	100	95	125	212	280	65	12	263	127	136	-	514	-	-	253	-	-	PG16	-	53,0	-
3D 65-125/5.5	80	138	160	200	22	65	122	145	185	20	340	160	180	-	150	100	95	125	212	280	65	12	263	127	136	-	539	-	-	275	PG13,5	-	PG16	-	65,0	-
3D 65-125/7.5	80	138	160	200	22	65	122	145	185	20	340	160	180	-	150	100	95	125	212	280	65	12	263	127	136	-	539	559	-	275	PG13,5	-	PG16	-	-	72,6
3D 65-160/7.5	80	138	160	200	22	65	122	145	185	20	360	160	200	-	150	100	95	125	212	280	65	12	296	148	148	-	539	559	-	275	PG13,5	-	PG16	-	-	73,1
3D 65-160/9.2	80	138	160	200	22	65	122	145	185	20	360	160	200	-	178	100	95	125	212	280	65	12	296	148	148	-	595	-	-	359	PG13,5	-	PG21	-	-	85,0
3D 65-160/11	80	138	160	200	22	65	122	145	185	20	360	160	200	-	178	100	95	125	212	280	65	12	296	148	148	-	595	-	-	359	PG13,5	-	PG21	-	-	87,4

[1]= Only three-phase [2]= Only single-phase [*]= Only IE3 motors

The contents of this publication must not be regarded as binding. EBARA Pumps Europe S.p.A. reserves the right to effect any modification it deems necessary, without prior notice.

3D SERIES

NORMALISED AND MONOBLOCK CENTRIFUGAL ELECTROPUMPS CONFORMING TO EN 733 (EX DIN 24255)

ELECTRIC DATA TABLE 3D SERIES

2 Poles

Single-phase 230V	Model Three-phase 230/400/690V	P ₁		Motor efficiency		Capacitor		Efficiency (%)			Absorbed Current [A]			
		[HP]	[kW]	Single-phase	Three-phase	Single-phase µF	V _c	Three-phase			Single-phase 230V	Three-phase		
								η %	75%	100%		230V	400V	690V
3D 32-125/1.1 M	3D 32-125/1.1	1,5	1,1	-	IE2	31,5	450	79,5	82,0	82,5	6,7	5,6	3,2	-
3D 32-160/1.5 M	3D 32-160/1.5	2	1,5	-	IE2	40	450	79,5	82,0	82,5	9,6	5,6	3,2	-
3D 32-160/2.2 M	3D 32-160/2.2	3	2,2	-	IE2	50	450	83,1	85,7	86,2	13,3	7,8	4,5	-
-	3D 32-200/3.0	4	3	-	IE2	-	-	85,0	86,7	86,3	-	10,6	6,1	-
-	3D 32-200/4.0	5,5	4	-	IE2	-	-	84,3	87,2	87,8	-	15,1	8,7	-
-	3D 32-200/7.5	10	7,5	-	IE3	-	-	89,0	90,7	90,8	-	-	13,6	7,9
3D 40-125/1.5 M	3D 40-125/1.5	2	1,5	-	IE2	40	450	79,5	82,0	82,5	9,6	5,6	3,2	-
3D 40-125/2.2 M	3D 40-125/2.2	3	2,2	-	IE2	50	450	83,1	85,7	86,2	13,3	7,8	4,5	-
-	3D 40-160/3.0	4	3	-	IE2	-	-	85,0	86,7	86,3	-	10,6	6,1	-
-	3D 40-160/4.0	5,5	4	-	IE2	-	-	84,3	87,2	87,8	-	15,1	8,7	-
-	3D 40-200/5.5	7,5	5,5	-	IE2	-	-	82,9	86,0	87,4	-	-	10,4	6,0
-	3D 40-200/7.5	10	7,5	-	IE3	-	-	89,0	90,7	90,8	-	-	13,6	7,9
-	3D 40-200/11	15	11	-	IE3	-	-	90,4	91,2	91,8	-	-	21,3	12,3
3D 50-125/2.2 M	3D 50-125/2.2	3	2,2	-	IE2	50	450	83,1	85,7	86,2	13,3	7,8	4,5	-
-	3D 50-125/3.0	4	3	-	IE2	-	-	85,0	86,7	86,3	-	10,6	6,1	-
-	3D 50-125/4.0	5,5	4	-	IE2	-	-	84,3	87,2	87,8	-	15,1	8,7	-
-	3D 50-160/5.5	7,5	5,5	-	IE2	-	-	82,9	86,0	87,4	-	-	10,4	6,0
-	3D 50-160/7.5	10	7,5	-	IE3	-	-	89,0	90,7	90,8	-	-	13,6	7,9
-	3D 50-200/9.2	12,5	9,2	-	IE3	-	-	90,1	90,8	90,9	-	-	17,2	10,0
-	3D 50-200/11	15	11	-	IE3	-	-	90,4	91,2	91,8	-	-	21,3	12,3
-	3D 50-200/15	20	15	-	IE3	-	-	91,2	92,0	91,9	-	-	27,7	17,3
-	3D 65-125/4.0	5,5	4	-	IE2	-	-	84,3	87,2	87,8	-	15,1	8,7	-
-	3D 65-125/5.5	7,5	5,5	-	IE2	-	-	82,9	86,0	87,4	-	-	10,4	6,0
-	3D 65-125/7.5	10	7,5	-	IE3	-	-	89,0	90,7	90,8	-	-	13,6	7,9
-	3D 65-160/7.5	10	7,5	-	IE3	-	-	89,0	90,7	90,8	-	-	13,6	7,9
-	3D 65-160/9.2	12,5	9,2	-	IE3	-	-	90,1	90,8	90,9	-	-	17,2	10,0
-	3D 65-160/11	15	11	-	IE3	-	-	90,4	91,2	91,8	-	-	21,3	12,3
-	3D 65-160/15	20	15	-	IE3	-	-	91,2	92,0	91,9	-	-	27,7	17,3
-	3D 65-200/15	20	15	-	IE3	-	-	91,2	92,0	91,9	-	-	27,7	17,3
-	3D 65-200/18.5	25	18,5	-	IE3	-	-	91,6	93,0	92,6	-	-	35,0	20,3
-	3D 65-200/22	30	22	-	IE3	-	-	92,0	93,1	93,2	-	-	39,7	23,6

3D SERIES

NORMALISED AND MONOBLOCK CENTRIFUGAL ELECTROPUMPS CONFORMING TO EN 733 (EX DIN 24255)

NOISE DATA TABLE 3D SERIES

2 Poles

Model	P ₂		L _{pa} - dB(A)*
	[HP]	[kW]	
3D 32-125/1.1 (M)	1,5	1,1	69
3D 32-160/1.5 (M)	2	1,5	
3D 32-160/2.2 (M)	3	2,2	
3D 32-200/3.0	4	3	76
3D 32-200/4.0	5,5	4	
3D 32-200/7.5	10	7,5	79
3D 40-125/1.5 (M)	2	1,5	69
3D 40-125/2.2 (M)	3	2,2	
3D 40-160/3.0	4	3	76
3D 40-160/4.0	5,5	4	
3D 40-200/5.5	7,5	5,5	79
3D 40-200/7.5	10	7,5	
3D 40-200/11	15	11	82
3D 50-125/2.2 (M)	3	2,2	69
3D 50-125/3.0	4	3	76
3D 50-125/4.0	5,5	4	
3D 50-160/5.5	7,5	5,5	79
3D 50-160/7.5	10	7,5	
3D 50-200/9.2	12,5	9,2	82
3D 50-200/11	15	11	
3D 50-200/15	20	15	86
3D 65-125/4.0	5,5	4	76
3D 65-125/5.5	7,5	5,5	79
3D 65-125/7.5	10	7,5	
3D 65-160/7.5	10	7,5	82
3D 65-160/9.2	12,5	9,2	
3D 65-160/11	15	11	86
3D 65-160/15	20	15	
3D 65-200/15	20	15	
3D 65-200/18.5	25	18,5	
3D 65-200/22	30	22	

* Mean value of several measures at 1m distance around the pump.
Tolerance ± 2.5 dB.

NOISE DATA TABLE 3DS - 3DP SERIES

2 Poles

Model		P ₂		L _{pa} - dB(A)*
3DS	3DP	[HP]	[kW]	
3DS 32-125/1.1	3DP 32-125/1.1	1,5	1,1	<70
3DS 32-160/1.5	3DP 32-160/1.5	2	1,5	
3DS 32-160/2.2	3DP 32-160/2.2	3	2,2	
3DS 32-200/3.0	3DP 32-200/3.0	4	3	73
3DS 32-200/4.0	3DP 32-200/4.0	5,5	4	
3DS 32-200/7.5	3DP 32-200/7.5	10	7,5	77
3DS 40-125/1.5	3DP 40-125/1.5	2	1,5	<70
3DS 40-125/2.2	3DP 40-125/2.2	3	2,2	
3DS 40-160/3.0	3DP 40-160/3.0	4	3	73
3DS 40-160/4.0	3DP 40-160/4.0	5,5	4	
3DS 40-200/5.5	3DP 40-200/5.5	7,5	5,5	77
3DS 40-200/7.5	3DP 40-200/7.5	10	7,5	
3DS 40-200/11	3DP 40-200/11	15	11	79
3DS 50-125/2.2	3DP 50-125/2.2	3	2,2	<70
3DS 50-125/3.0	3DP 50-125/3.0	4	3	
3DS 50-125/4.0	3DP 50-125/4.0	5,5	4	73
3DS 50-160/5.5	3DP 50-160/5.5	7,5	5,5	
3DS 50-160/7.5	3DP 50-160/7.5	10	7,5	77
3DS 50-200/9.2	3DP 50-200/9.2	12,5	9,2	
3DS 50-200/11	3DP 50-200/11	15	11	79
3DS 50-200/15	3DP 50-200/15	20	15	
3DS 65-125/4.0	3DP 65-125/4.0	5,5	4	73
3DS 65-125/5.5	3DP 65-125/5.5	7,5	5,5	
3DS 65-125/7.5	3DP 65-125/7.5	10	7,5	77
3DS 65-160/7.5	3DP 65-160/7.5	10	7,5	
3DS 65-160/9.2	3DP 65-160/9.2	12,5	9,2	79
3DS 65-160/11	3DP 65-160/11	15	11	
3DS 65-160/15	3DP 65-160/15	20	15	80
3DS 65-200/15	3DP 65-200/15	20	15	
3DS 65-200/18.5	3DP 65-200/18.5	25	18,5	
3DS 65-200/22	3DP 65-200/22	30	22	

* Mean value of several measures at 1m distance around the pump.
Tolerance ± 2.5 dB.