

2025

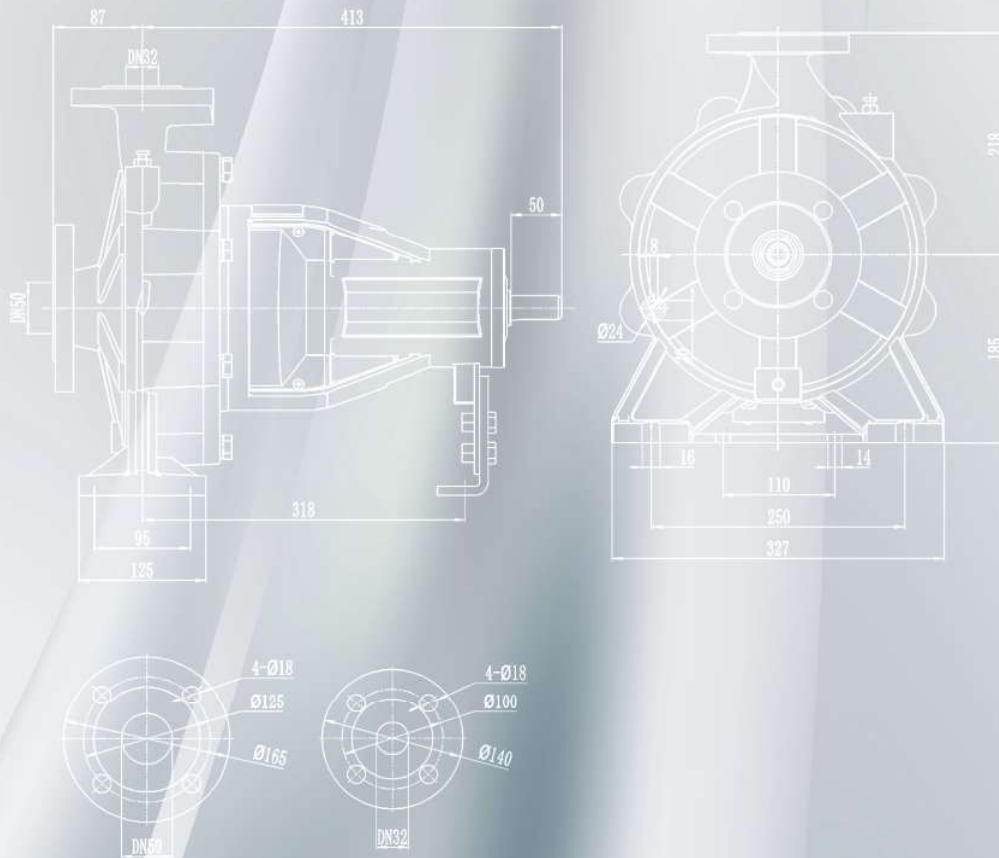

DESCRIPTION

- ◆ Complete range with a full series of end suction pumps
- ◆ Original design by MARO
- ◆ Outstanding reliability for operation in any application
- ◆ YE3 high efficient motor, with protection IP55 class F
- ◆ Pump case with anti-corrosive coating
- ◆ Customize casting logo on the bearing house as request
- ◆ Quality NSK bearing, wear resistance mechanical seal

APPLICATIONS

The impressive range end-suction pumps is compatible with an array of application areas, including water intake, heating, industrial pressure boosting, industrial liquid transfer, air-conditioning, district cooling, irrigation, fire fighting and many more.



CA/CA4

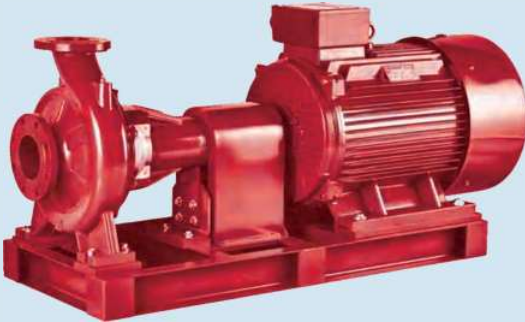

MODEL CODE

For example

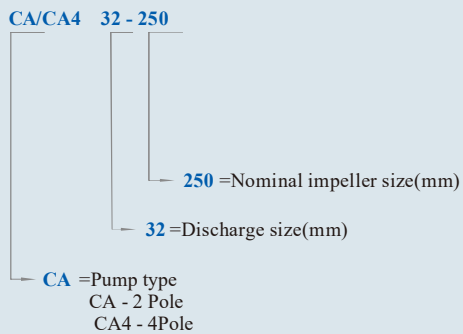

USING LIMITS

- ◆ Liquid temperature between -10°C and $+120^{\circ}\text{C}$
- ◆ Ambient temperature between -10°C and $+50^{\circ}\text{C}$
- ◆ Max. working pressure **16 bar**
- ◆ Continuous service S1

TECHNICAL SHEET

Model	CA/CA4	
Capacity	0-1000	m ³ /h
Head	0-164	m
DN	32-150	mm
Speed	2900	rpm
T max	120	°C
Power	1.5-315	kW
Casing	Grey cast iron	
Impeller	Cast iron/AISI 304/Brass	
Shaft	45# steel/AISI 304	
Shaft seal	Mechanical Seal	
Bearing	Grease lubrication rolling bearing	

CA/CA4

End suction centrifugal pump

TECHNICAL DATA

50 Hz n=2900 1/min

MODEL	DN mm	Implr Φ mm	Power kw hp		Q=DELIVERY																		
					H=Head																		
					0	264	396	529	634	793	881	925	969	1057	1233	1322	1586	1762	2203	2643	2907	3524	4405
					l/min	1000	1500	2000	2400	3000	3333	3500	3667	4000	4667	5000	6000	6667	8333	10000	11000	13333	16667
m ³ /h	60	90	120	144	180	200	210	220	240	280	300	360	400	500	600	660	800	1000					
CA 80-160	100x80	160	11	15	28	27	27.3	24.5	21.1	16	-	-	-	-	-	-	-	-	-				
CA 80-160	100x80	168	15	20	34	32.6	32.5	30.2	27	22.1	18.5	16.7	-	-	-	-	-	-	-				
CA 80-160	100x80	180	18.5	25	39	38.5	38	36.7	33.6	28.8	25.3	23.5	-	-	-	-	-	-	-				
CA 80-160	100x80	190	22	30	44	43.5	43	41.7	38.6	33.8	30.3	28.5	-	-	-	-	-	-	-				
CA 80-200	100x80	190	22	30	48	47.7	47.5	43.5	39.2	32.5	27.2	24.5	-	-	-	-	-	-	-				
CA 80-200	100x80	215	30	40	60	59.7	59.5	57	53.1	47	42.7	40.5	-	-	-	-	-	-	-				
CA 80-250	100x80	226	37	50	71.5	70.9	70.5	65.5	59.3	51	43.2	38.5	-	-	-	-	-	-	-				
CA 80-250	100x80	240	45	60	88	86.7	86	83.6	78.5	70.5	60	51	-	-	-	-	-	-	-				
CA 80-250	100x80	258	55	75	94.5	94.5	94.5	91.8	87	79.5	72.1	68.3	-	-	-	-	-	-	-				
CA 80-250	100x80	276	75	100	108.5	108.5	108.5	105.8	101	93.5	86.1	82.3	-	-	-	-	-	-	-				
CA 80-315	100x80	255	45	60	85	84	82.6	82	78	68.3	61	56	-	-	-	-	-	-	-				
CA 80-315	100x80	270	55	75	98	97	95.6	95	91	81.3	74	69	-	-	-	-	-	-	-				
CA 80-315	100x80	295	75	100	124	123	121.6	121	117	107.3	100	95	90	80.8	-	-	-	-	-				
CA 80-315	100x80	320	90	125	144	143	141.6	141	137	127.3	120	115	110	100.8	-	-	-	-	-				
CA 80-315	100x80	328	110	150	153	152	150.6	150	146	136.3	129	124	119	109.8	-	-	-	-	-				
CA 100-160	125x100	167	15	20	35	33.5	32.5	30	27.8	24.5	21.5	20	18.3	15	-	-	-	-	-				
CA 100-160	125x100	176	18.5	25	38.5	37.5	36.5	34.3	32.2	29	25.7	24	22	18	-	-	-	-	-				
CA 100-160	125x100	190	22	30	43	41	40	37.6	35.2	31.5	28.5	27	25.3	22	-	-	-	-	-				
CA 100-200	125x100	185	22	30	38.5	36.7	35.7	33.8	31.7	28.5	26.8	26	25	22.9	16.3	13	-	-	-				
CA 100-200	125x100	195	30	40	44.5	42.5	42	40.2	38.8	36.7	34.2	33	31.7	29	21.7	18	-	-	-				
CA 100-200	125x100	208	37	50	55	53	51	50.6	49.2	47	45	44	42.8	40.5	32.8	29	-	-	-				
CA 100-200	125x100	218	45	60	61	59	57	56.6	55.2	53	51	50	48.8	46.5	38.8	35	-	-	-				
CA 100-250	125x100	220	45	60	65	65	64	63	61	58	56	55	53.3	50	39	33.5	-	-	-				
CA 100-250	125x100	240	55	75	77	76	75.5	75	73.8	72	71.7	71.5	70.7	69	62.3	59	-	-	-				
CA 100-250	125x100	257	75	100	91	91	90.5	89.7	88	85.5	84	83.3	81.5	78	71.7	68.5	48	-	-				
CA 100-250	125x100	270	90	125	100	100	99.5	98.7	97	94.5	93	92.3	90.5	87	80.7	77.5	57	-	-				
CA 100-315	125x100	255	75	100	80	-	-	78.5	76.7	74	73	72.8	72.5	70.7	68	64	52	-	-				
CA 100-315	125x100	280	90	125	100	-	-	98.5	96.7	94	93	92.8	92.5	90.7	88	84	72	-	-				
CA 100-315	125x100	300	110	150	118	-	-	116.5	114.7	112	111	110.8	110.5	108.7	106	102	90	-	-				
CA 100-315	125x100	315	132	180	129	-	-	127.5	125.7	123	122	121.8	121.5	119.7	117	112	101	-	-				
CA 100-315	125x100	328	160	220	148	-	-	146.5	144.7	142	141	140.8	140.5	138.7	136	132	120	-	-				
CA 125-200	150x125	190	45	60	39.8	-	-	39.3	39.2	39	38.9	38.9	38.8	37.5	35	34	28.6	25	-				
CA 125-200	150x125	205	55	75	50.5	-	-	49.3	49.2	49	48.9	48.9	48.8	47.5	45	44	38.6	35	-				
CA 125-200	150x125	218	75	100	61.5	-	-	60.3	60.2	60	59.9	59.9	59.8	58.5	56	55	49.6	46	-				
CA 125-250	150x125	240	55	75	70	-	-	67	66	64	63	62	61	59.5	54	50.5	-	-	-				
CA 125-250	150x125	255	75	100	80	-	-	76.5	75.5	74	73	72	71.5	70	67	65	56	-	-				
CA 125-250	150x125	265	90	125	87	-	-	84	82.5	81	79.5	79	78	77	73.5	71.5	65	60	-				
CA 125-250	150x125	274	110	150	97	-	-	94	92.8	91	90	89.3	88.7	87.4	84	83.5	76	71	-				
CA 125-250H	150x125	220	90	125	63.2	-	-	62.4	62	61.6	61.2	61.2	61.2	60.8	60	59.6	57.2	55.2	47.2				
CA 125-250H	150x125	240	110	150	74	-	-	73.2	72.8	72.4	72	72	72	71.6	70.8	70.4	68	66	58				
CA 125-250H	150x125	260	132	180	84	-	-	83.2	82.8	82.4	82	82	82	81.6	80.8	80.4	78	76	68				
CA 125-250H	150x125	280	160	220	98	-	-	97.2	96.8	96.4	96	96	96	95.6	94.8	94.4	92	90	82				
CA 125-315	150x125	280	132	180	96	-	-	-	-	-	95.2	95.1	95	94.8	94	93.5	91.8	88.5	76				
CA 125-315	150x125	295	160	220	112	-	-	-	-	-	111.2	111.1	111	110.8	110	109.5	107.8	106	97.5				
CA 125-315	150x125	310	185	250	125	-	-	-	-	-	124.2	124.1	124	123.8	123	122.5	120.8	119	109				
CA 125-315	150x125	328	200	270	136	-	-	-	-	-	135.2	135.1	135	134.8	134	133.5	131.8	130	120				
CA 150-200	200x150	205	75	100	50	-	-	-	-	-	-	-	48	47.9	47.6	47.2	45.8	44.6	41				
CA 150-200	200x150	217	90	125	56	-	-	-	-	-	-	-	54	53.9	53.6	53.2	52.7	52.4	48				
CA 150-200	200x150	235	110	150	65.2	-	-	-	-	-	-	-	62	61.7	61.2	60.8	59.8	59.2	57.2				
CA 150-200	200x150	245	132	180	71	-	-	-	-	-	-	-	68.5	67.7	67.2	66.8	65.8	65.2	60				
CA 150-200	200x150	258	160	220	77	-	-	-	-	-	-	-	74	74	73.2	72.8	71.8	71.2	69.2				
CA 150-250	200x150	242	110	150	67	-	-	-	-	-	-	-	-	-	63	61.7	60	55.8	51.8				
CA 150-250	200x150	265	132	180	80.2	-	-	-	-	-	-	-	-	-	78	76.3	73.5	70	65				
CA 150-250	200x150	280	160	220	90	-	-	-	-	-	-	-	-	-	88	86	85	82	77.2				
CA 150-250	200x150	295	200	270	100	-	-	-	-	-	-	-	-	-	97	96	95	92	87.2				
CA 150-315	200x150	287	185	250	92	-	-	-	-	-	-	-	-	-	90	88.3	87.2	82.8	77.8				
CA 150-315	200x150	305	250	340	111	-	-	-	-	-	-	-	-	-	110	108	106	102	96				
CA 150-315	200x150	315	280	380	124	-	-	-	-	-	-	-	-	-	121	119	118	114	109				
CA 150-315	200x150	327	315	430	135	-	-	-	-	-	-	-	-	-	134	133	132	128	122				

TECHNICAL DATA

50 Hz n=1450 1/min

MODEL	DN mm	Implr φ mm	Power kw hp		Q-DELIVERY																	
					us gpm	0	132	154	176	220	264	396	441	485	617	661	881	1101	1322	1762	2203	2643
					l/min	0	500	583	667	833	1000	1500	1667	1833	2333	2500	3333	4167	5000	6667	8333	10000
					m ³ /h	0	30	35	40	50	60	90	100	110	140	150	200	250	300	400	500	600
CA4 125-200	150x125	190	5.5	7.5	11.4	11.1	11.1	11	10.9	10.8	10.2	10	9.7	8.9	8.6	6.9	-	-	-	-	-	
CA4 125-200	150x125	205	7.5	10	14.1	13.9	13.8	13.8	13.7	13.6	13.1	12.9	12.7	11.9	11.6	9.6	-	-	-	-	-	
CA4 125-200	150x125	218	11	15	18.1	17.9	17.8	17.8	17.7	17.6	17.1	16.9	16.7	15.9	15.6	13.6	9.8	-	-	-	-	
CA4 125-250	150x125	215	7.5	10	15.4	-	-	-	-	15.3	15	14.8	14.6	13.6	13.1	-	-	-	-	-	-	
CA4 125-250	150x125	240	11	15	19.4	-	-	-	-	19.3	19.1	19	18.9	18.1	17.8	15.3	11.7	-	-	-	-	
CA4 125-250	150x125	265	15	20	23.2	-	-	-	-	23.3	23.1	23	22.9	22	22	19.8	16.5	12.3	-	-	-	
CA4 125-250	150x125	274	18.5	25	25.6	-	-	-	-	25.5	25.5	25.4	25.3	24.9	24.7	23	20.3	16.5	-	-	-	
CA4 125-315	150x125	280	18.5	25	27.3	-	-	-	-	-	-	26.9	26.7	25.9	25.6	23.3	19.7	14.9	-	-	-	
CA4 125-315	150x125	295	22	30	30	-	-	-	-	-	-	29.7	29.6	28.9	28.6	26.5	23.2	18.4	-	-	-	
CA4 125-315	150x125	310	30	40	35.6	-	-	-	-	-	-	35.4	35.3	34.8	34.6	32.9	30.1	26.1	-	-	-	
CA4 125-315	150x125	328	37	50	38.2	-	-	-	-	-	-	38	37.9	37.4	37.2	35.7	33.1	29.4	17.8	-	-	
CA4 125-400	150x125	350	30	40	41	-	-	-	-	-	41	40.5	40.3	39.2	38.6	34.4	27.5	18.3	-	-	-	
CA4 125-400	150x125	370	37	50	46.2	-	-	-	-	-	46	45.7	45.5	44.6	44.2	40.7	34.8	26.5	-	-	-	
CA4 125-400	150x125	390	45	60	51.4	-	-	-	-	-	51	50.9	50.8	50.1	49.8	47	42.2	34.8	-	-	-	
CA4 125-400	150x125	410	55	75	56.5	-	-	-	-	-	56.3	56.3	56.2	55.9	55.7	53.8	50.3	44.7	26.7	-	-	
CA4 125-400	150x125	425	75	100	64.5	-	-	-	-	-	64.3	64.3	64.2	63.9	63.7	61.8	58.3	52.7	34.7	-	-	
CA4 125-400	150x125	440	90	125	70	-	-	-	-	-	69.8	69.8	69.7	69.4	69.2	67.3	63.8	58.2	40.2	-	-	
CA4 150-200	200x150	225	11	15	14	-	-	-	-	-	-	13.5	13.4	13.3	13.1	12.9	11.7	7.8	-	-	-	
CA4 150-200	200x150	240	15	20	16.3	-	-	-	-	-	-	15.5	15.3	15.2	14.8	14.3	13.5	11.1	-	-	-	
CA4 150-200	200x150	250	18.5	25	18.3	-	-	-	-	-	-	17.5	17.3	17.2	16.8	16.3	15.5	13.1	10	-	-	
CA4 150-200	200x150	258	22	30	20.3	-	-	-	-	-	-	19.5	19.3	19.2	18.8	18.3	17.5	15.1	12	-	-	
CA4 150-250	200x150	242	15	20	17.5	-	-	-	-	-	-	-	-	-	16.8	15.9	14.7	13.2	9.2	-	-	
CA4 150-250	200x150	265	18.5	25	21.3	-	-	-	-	-	-	-	-	-	20.8	20	18.9	17.5	13.8	8.7	-	
CA4 150-250	200x150	280	22	30	24	-	-	-	-	-	-	-	-	-	23.6	23	22	20.8	17.1	12	-	
CA4 150-250	200x150	295	30	40	25.5	-	-	-	-	-	-	-	-	-	25	24.5	23.5	22	18.8	13.8	-	
CA4 150-315	200x150	287	30	40	30.2	-	-	-	-	-	-	-	-	-	29.7	29	27.9	26.4	22.3	-	-	
CA4 150-315	200x150	305	37	50	33.6	-	-	-	-	-	-	-	-	-	33.5	32.7	31.7	30.4	26.7	21.4	-	
CA4 150-315	200x150	327	45	60	37.7	-	-	-	-	-	-	-	-	-	37.6	36.9	35.9	34.7	31.3	26.5	-	
CA4 150-315	200x150	340	55	75	40	-	-	-	-	-	-	-	-	-	40	39.3	38.4	37.2	33.9	29.4	-	
CA4 150-315	200x150	365	75	100	47	-	-	-	-	-	-	-	-	-	47	46.3	45.4	44.2	40.9	36.4	29	
CA4 150-400	200x150	360	55	75	48.2	-	-	-	-	-	-	-	-	47.7	48	46	45	42	36.8	29.2	-	
CA4 150-400	200x150	385	75	100	55.4	-	-	-	-	-	-	-	-	55	55	54	53	51	47	41	32.2	
CA4 150-400	200x150	400	90	125	59.5	-	-	-	-	-	-	-	-	59	59	58	57	56	52	46	37.7	
CA4 150-400	200x150	420	110	150	65.5	-	-	-	-	-	-	-	-	65	65	64	63	62	58	52	43.7	
CA4 150-400	200x150	440	132	180	72	-	-	-	-	-	-	-	-	71.5	71.5	70.5	69.5	68.5	64.5	58.5	50.2	

MODEL	DN mm	Implr φ mm	Power kw hp		Q-DELIVERY																
					us gpm	0	881	1322	1762	2203	2643	3084	3524	3965	4405	4846	52	86	5727	6167	6608
					l/min	0	3333	5000	6667	8333	10000	11667	13333	15000	16667	18333	20000	21667	23333	25000	
					m ³ /h	0	200	300	400	500	600	700	800	900	1000	1100	1200	1300	1400	1500	
CA4 200-250	250x200	270	37	50	23	22	21	19.8	18.3	16.1	12.8	9.3	-	-	-	-	-	-	-	-	-
CA4 200-250	250x200	290	45	60	26	25	24	22.8	21.3	19.1	15.8	12.3	-	-	-	-	-	-	-	-	-
CA4 200-250	250x200	310	55	75	30.7	29.7	28.7	27.5	26	23.8	20.5	17	-	-	-	-	-	-	-	-	-
CA4 200-315	250x200	310	55	75	31.1	31	30	29.3	27.5	25	21.3	16	-	-	-	-	-	-	-	-	-
CA4 200-315	250x200	330	75	100	35.1	35	34	33.3	31.5	29	25.3	20	-	-	-	-	-	-	-	-	-
CA4 200-315	250x200	360	90	125	42.1	42	41	40.3	38.5	36	32.3	27	-	-	-	-	-	-	-	-	-
CA4 200-400	250x200	350	75	100	41	40.9	40.4	38.9	37.4	34.9	32.9	28.9	-	-	-	-	-	-	-	-	-
CA4 200-400	250x200	370	90	125	46.5	46.4	45.9	44.4	42.9	40.4	38.4	34.4	-	-	-	-	-	-	-	-	-
CA4 200-400	250x200	395	110	150	52.4	52.3	51.8	50.3	48.8	46.3	44.3	40.3	-	-	-	-	-	-	-	-	-
CA4 200-400	250x200	420	132	180	60.1	60	59.5	58	56.5	54	52	48	40	-	-	-	-	-	-	-	-
CA4 250-315	300x250	320	90	125	30.5	-	-	29	28.3	28	27.6	27	26.4	25.8	24.8	23	21.8	-	-	-	-
CA4 250-315	300x250	340	110	150	34.5	-	-	33	32.3	32	31.6	31	30.4	29.8	28.8	27	25.8	-	-	-	-
CA4 250-315	300x250	360	132	180	38.5	-	-	37	36.3	36	35.6	35	34.4	33.8	32.8	31	29.8	28	-	-	-
CA4 250-315	300x250	390	160	220	45	-	-	43.5	42.8	42.5	42.1	41.5	40.9	40.3	39.3	37.5	36.3	34.5	-	-	-
CA4 250-400	300x250	365	160	220	43	-	-	42	41.2	40.8	40	39	38	37	36	34	32.5	30	-	-	-
CA4 250-400	300x250	380	185	250	47	-	-	46	45.2	44.8	44	43	42	41	40	38	36.5	34	-	-	-
CA4 250-400	300x250	400	200	270	53	-	-	52	51.2	50.8	50	49	48	47	46	44	42.5	40	38	-	-
CA4 250-400	300x250	420	220	300	58	-	-	57	56.2	55.8	55	54	53	52	51	49	47.5	45	43	-	-
CA4 250-400	300x250	448	250	340	66	-	-	65	64.2	63.8	63	62	61	60	59	57	55.5	53	51	-	-

MATERIAL DESCRIPTION

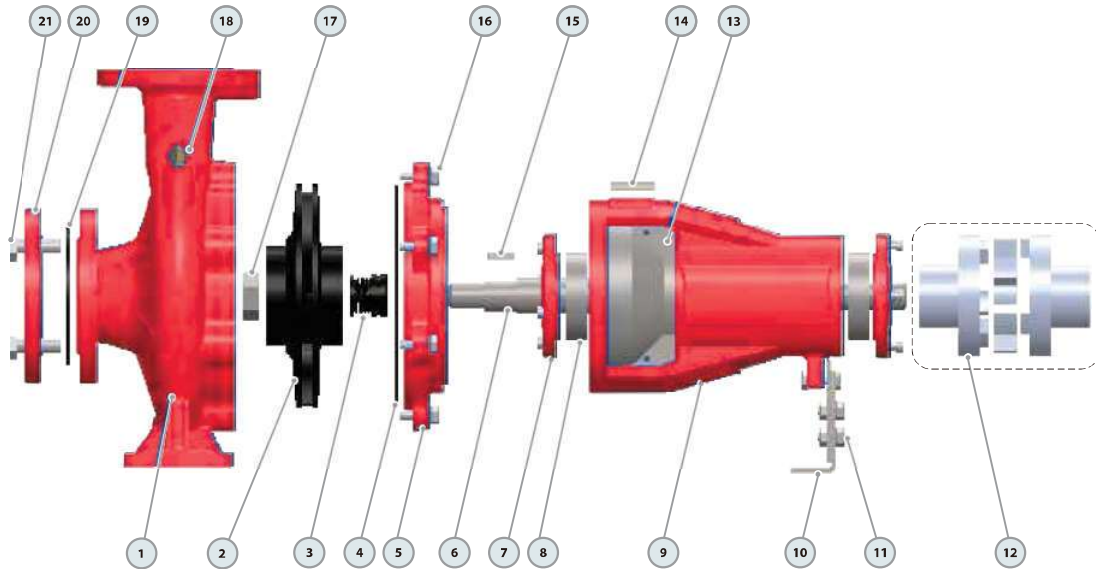

No.	Description	Material	No.	Description	Material	No.	Description	Material
1	Pump Case	Cast iron	8	Bearing	Ball Bearing	15	Impeller Key	Iron
2	Impeller	SS304/Cast iron	9	Support Case	Cast iron	16	Connection Bolt	Steel
3	Mechanical Seal	SiC/Carbon/SS304	10	Support Foot	Iron	17	Impeller Nut	Galvanized Steel
4	O-ring	Rubber	11	Foot Bolt	Steel	18	Release Valve	Brass
5	Connection	Cast iron	12	Coupling(Optional)	Steel	19	Gasket	Rubber
6	Shaft	SS304/45# Steel	13	Case Cover	SS304	20	Counter Flange	Galvanized Cast iron
7	Bearing Cover	Cast iron	14	Nameplate	Aluminum	21	Flange Bolt	Steel

DIMENSIONS AND WEIGHT

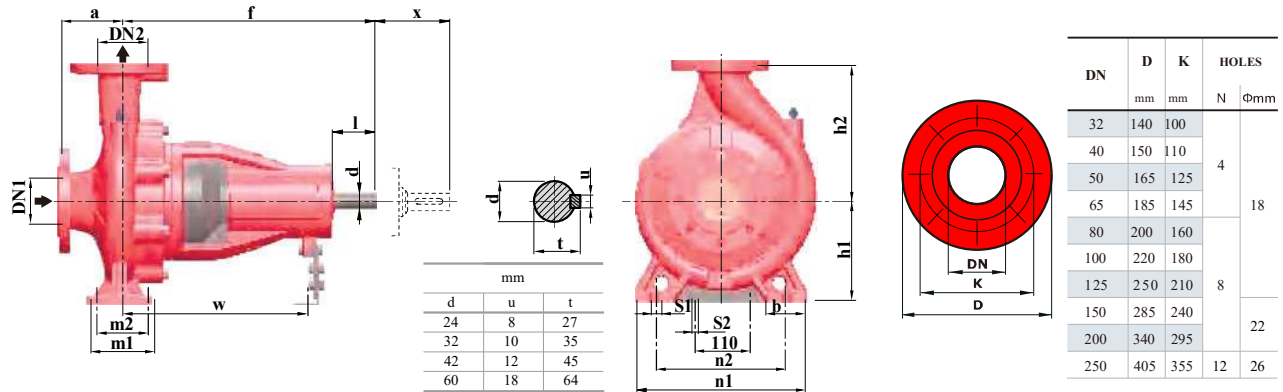

MODEL	DIMENSIONS																	kg
	DN1	DN2	a	f	h1	h2	b	m1	m2	n1	n2	s1	s2	w	x	d	l	
32-160	50	32	80	360	132	160	55	95	70	240	190	14	14	260	100	24	50	31
32-200	50	32	80	360	160	180	55	95	70	240	190	14	14	260	100	24	50	35
32-250	50	32	80	360	160	180	55	95	70	240	190	14	14	260	100	24	50	35
40-160	65	40	80	360	132	160	50	100	70	240	190	14	14	260	100	24	50	35
40-200	65	40	100	360	160	180	55	100	70	265	212	14	14	260	100	24	50	38
40-250	65	40	100	360	180	225	65	125	95	320	250	14	14	260	100	24	50	58
40-315	65	40	125	500	200	160	65	125	95	345	280	14	14	370	140	32	80	82
50-125	65	50	100	360	132	180	50	100	70	240	190	14	14	260	100	24	50	30
50-160	65	50	100	360	160	200	55	100	70	265	212	14	14	260	100	24	50	35
50-200	65	50	100	360	160	225	50	100	70	265	212	14	14	260	100	24	50	45
50-250	65	50	100	360	180	180	65	125	95	320	250	14	14	260	100	24	50	50
50-315	65	50	125	500	225	280	65	125	95	345	280	14	14	370	140	32	80	90
65-125	80	65	100	360	160	250	65	125	95	280	212	14	14	260	100	24	50	42
65-160	80	65	100	360	160	200	65	125	95	280	212	14	14	260	100	24	50	45
65-200	80	65	100	360	180	225	65	125	95	320	250	14	14	260	140	24	50	50
65-250	80	65	100	470	200	250	80	160	120	360	280	18	14	340	140	32	80	71
65-315	80	65	125	470	225	280	80	160	120	360	280	18	14	340	140	32	80	98
80-125	100	80	100	360	180	225	65	125	95	320	250	14	14	260	140	24	50	46
80-160	100	80	100	360	180	225	65	125	95	345	250	14	14	260	140	24	50	48
80-200	100	80	100	470	200	250	65	125	95	345	280	14	14	340	140	32	80	65
80-250	100	80	100	470	200	280	80	160	120	400	315	18	14	340	140	32	80	79
80-315	100	80	125	470	250	315	80	160	120	400	315	18	14	340	140	24	50	118
80-400	100	80	125	540	280	355	80	160	120	400	315	18	14	340	140	32	80	150
100-160	125	100	125	360	200	280	80	160	120	360	280	18	14	260	140	32	80	55
100-200	125	100	125	470	200	280	80	160	120	360	280	18	14	340	140	32	80	75
100-250	125	100	125	470	225	280	80	160	120	400	315	18	14	340	140	32	80	88
100-315	125	100	140	470	250	315	80	160	120	400	315	19	14	340	140	32	80	116
100-400	125	100	140	530	280	355	100	200	150	500	400	23	14	370	140	42	110	178
125-200	150	125	140	470	250	315	80	160	120	400	315	19	14	340	140	32	80	112
125-250	150	125	140	470	250	355	80	160	120	400	315	19	14	340	140	32	80	112
125-250H	150	125	140	530	250	355	80	160	120	400	315	19	14	370	140	42	110	140
125-315	150	125	140	530	280	355	100	200	150	500	400	23	14	370	140	42	110	152
125-400	150	125	140	530	315	400	100	200	150	500	400	23	14	370	140	42	110	200
150-200	200	150	160	470	280	400	100	200	150	550	450	23	14	370	140	32	80	166
150-250	200	150	160	530	280	400	100	200	150	550	450	23	14	370	140	42	110	180
150-315	200	150	160	530	280	400	100	200	150	550	450	23	14	370	140	42	110	186
150-400	200	150	160	530	315	450	100	200	150	550	450	23	14	370	140	42	110	228
200-250	250	200	180	530	355	475	100	200	150	550	450	23	14	370	200	42	110	230
200-315	250	200	180	530	355	450	100	200	150	550	450	23	14	370	200	42	110	234
200-400	250	200	180	770	400	500	110	300	250	710	600	28	14	525	250	60	140	363
250-315	300	250	250	530	400	500	110	300	250	710	600	28	14	525	250	42	110	316
250-400	300	250	250	770	400	560	110	300	250	710	600	28	14	525	250	60	140	400

50-125

2900rpm

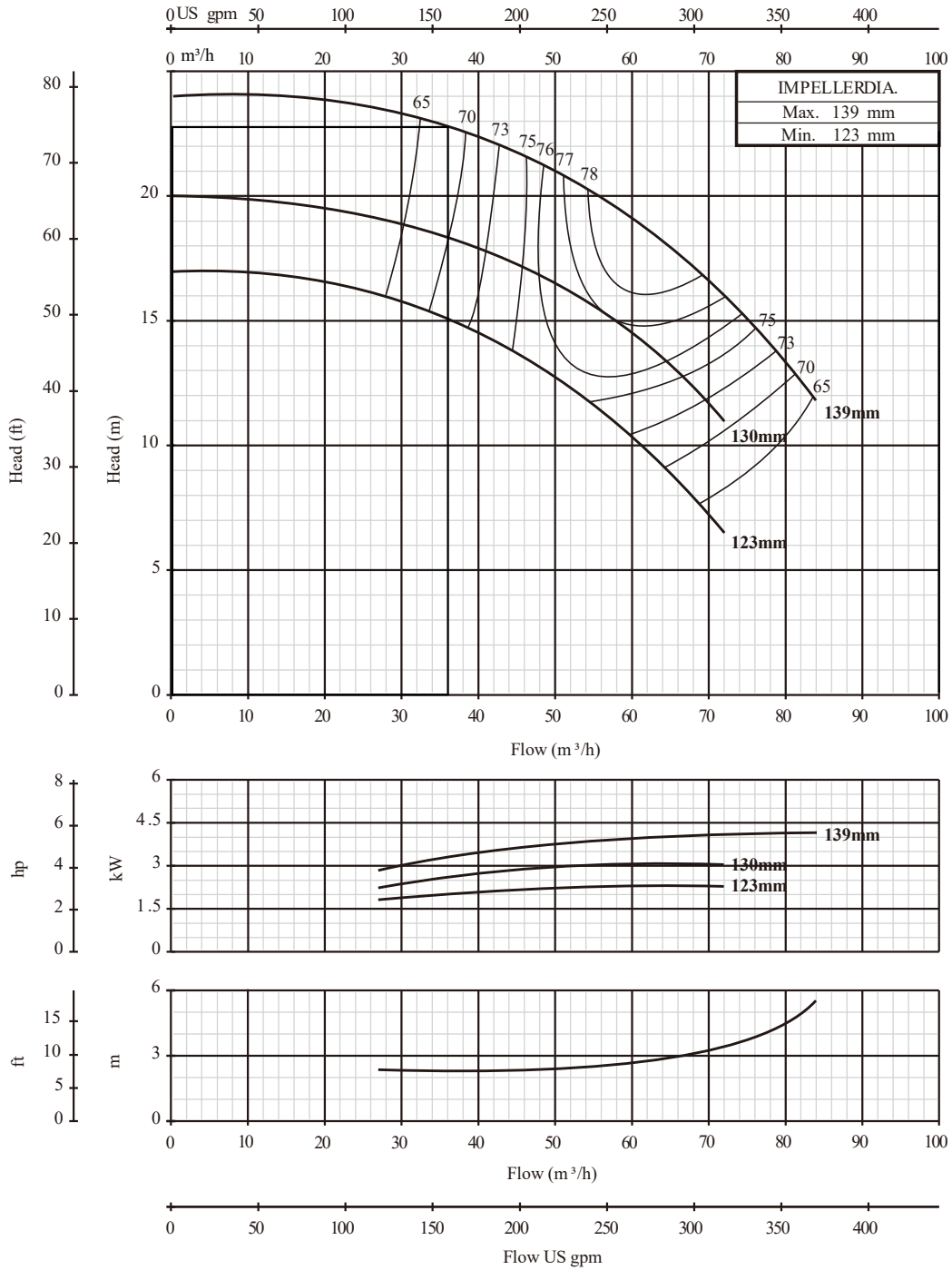

H - Q

P - Q

NPSHr

PERFORMANCE CURVE

50-160

2900rpm

PERFORMANCE CURVE

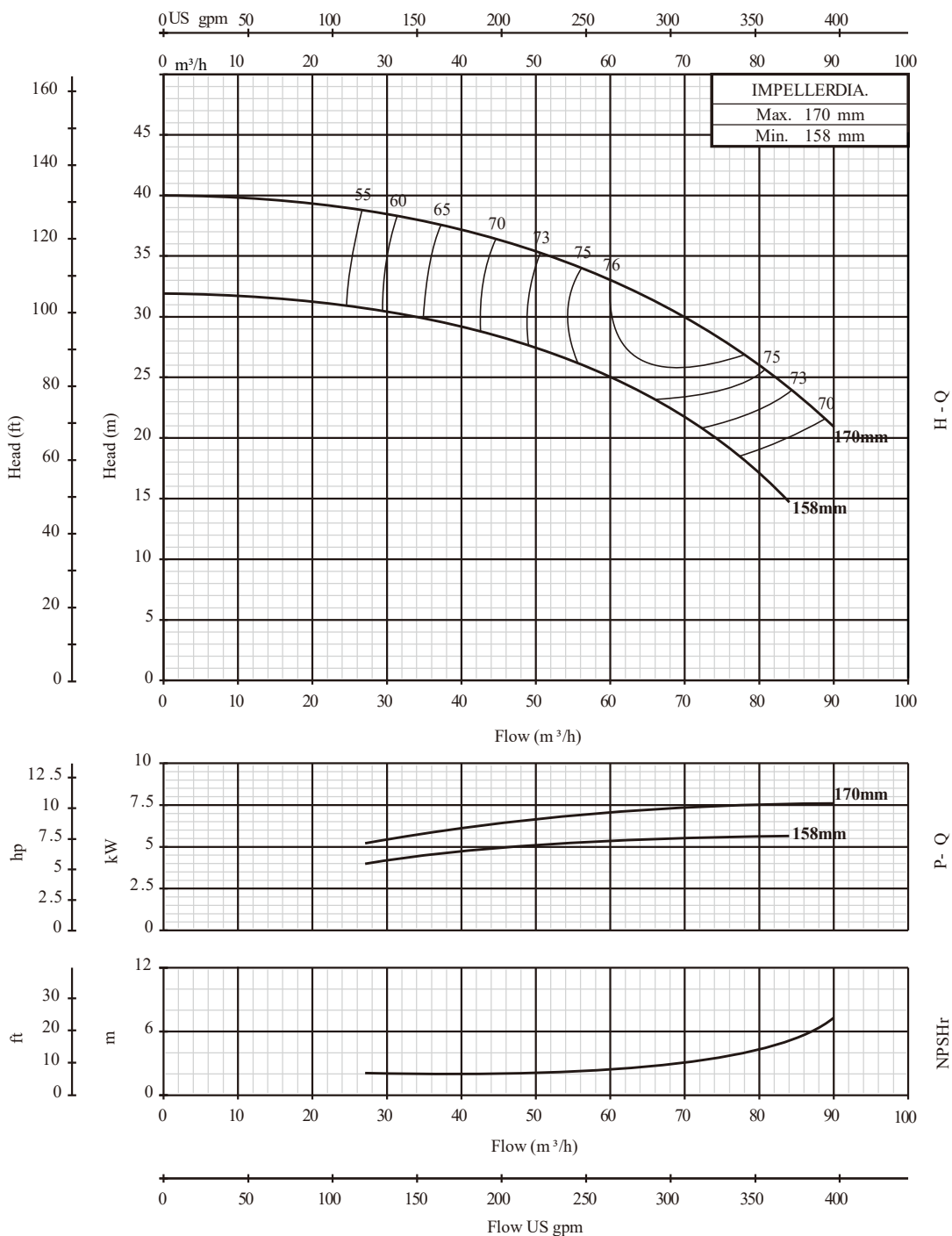

50-200

2900rpm

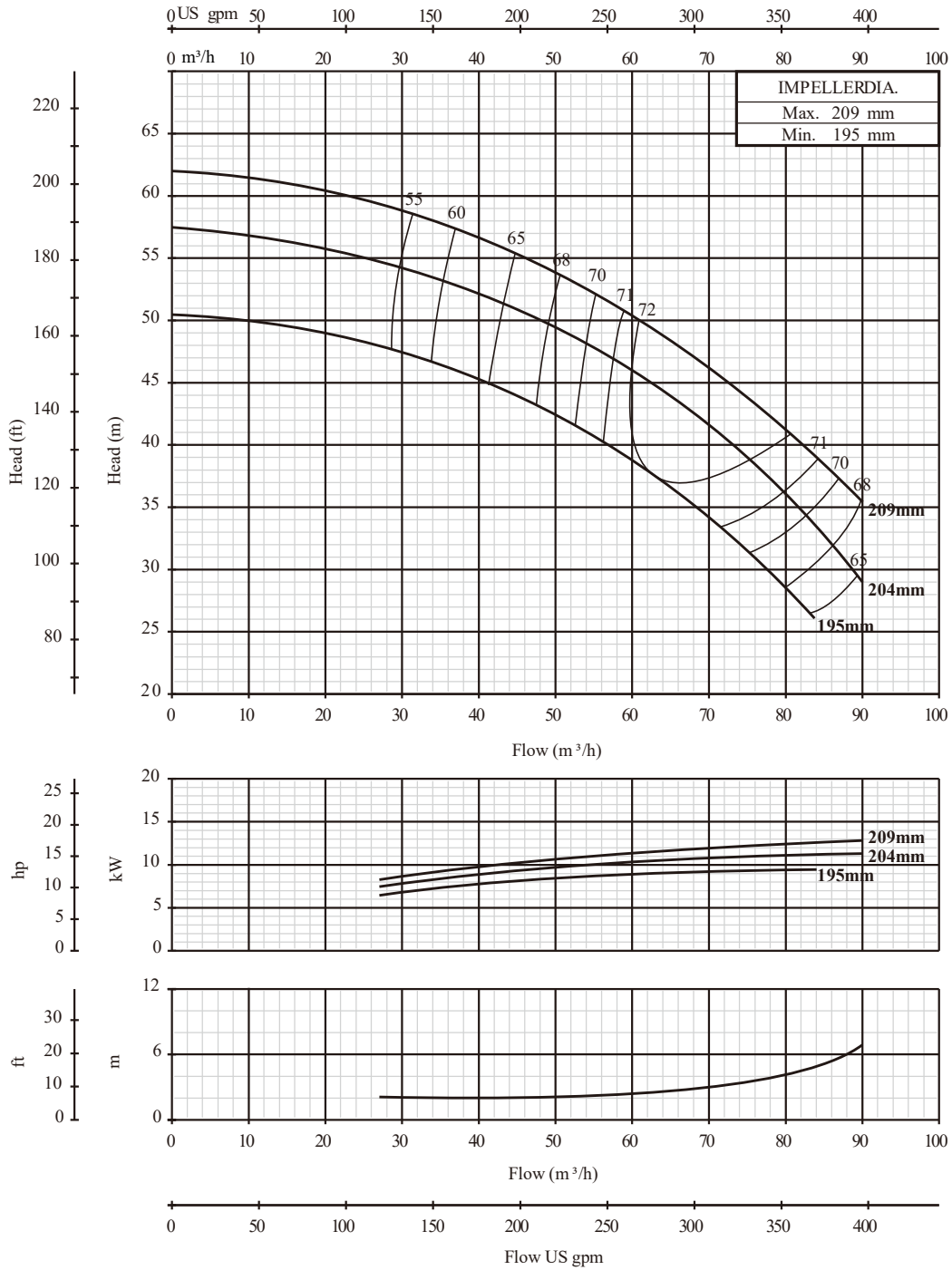

PERFORMANCE CURVE

50-250

2900rpm

PERFORMANCE CURVE

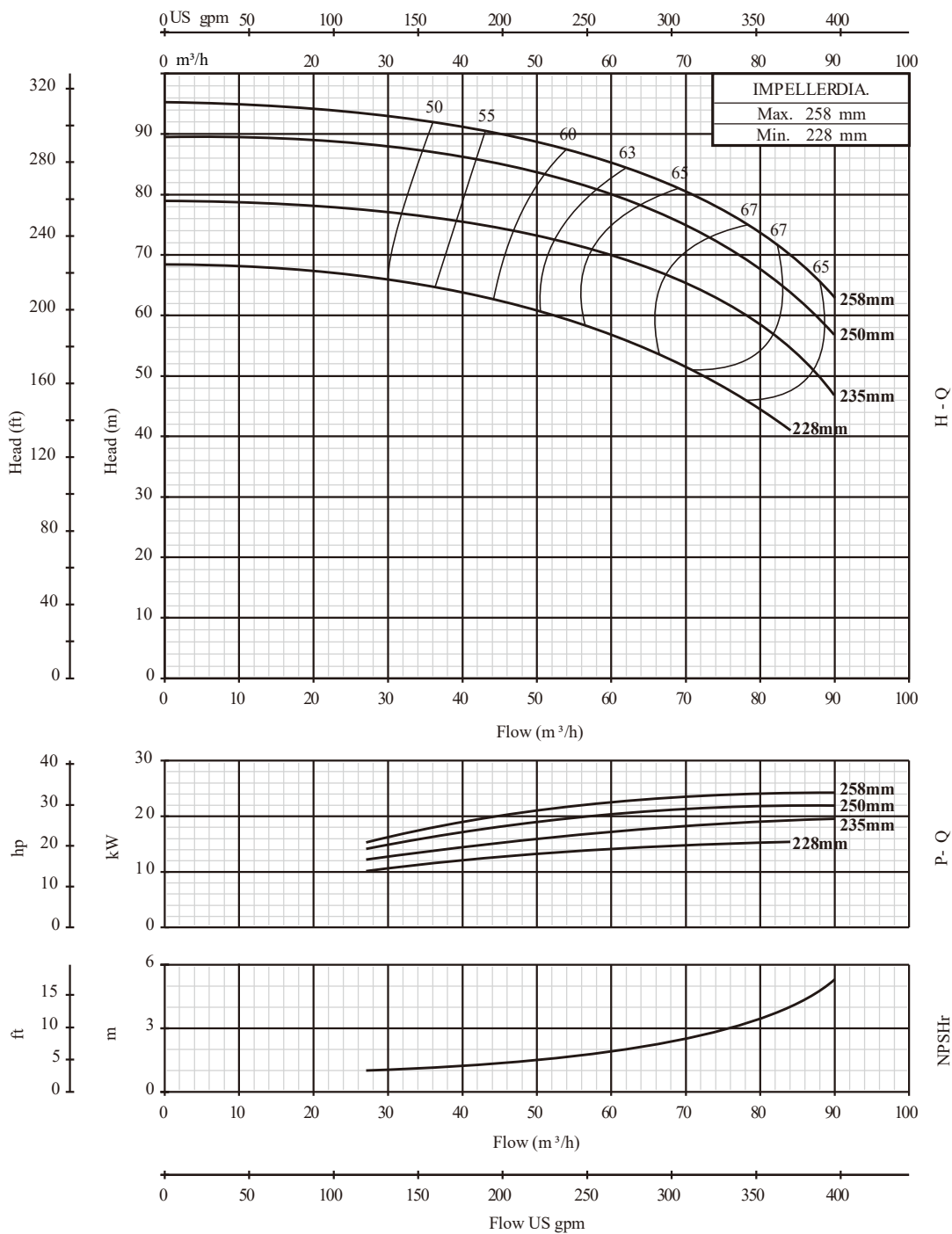

50-315

2900rpm

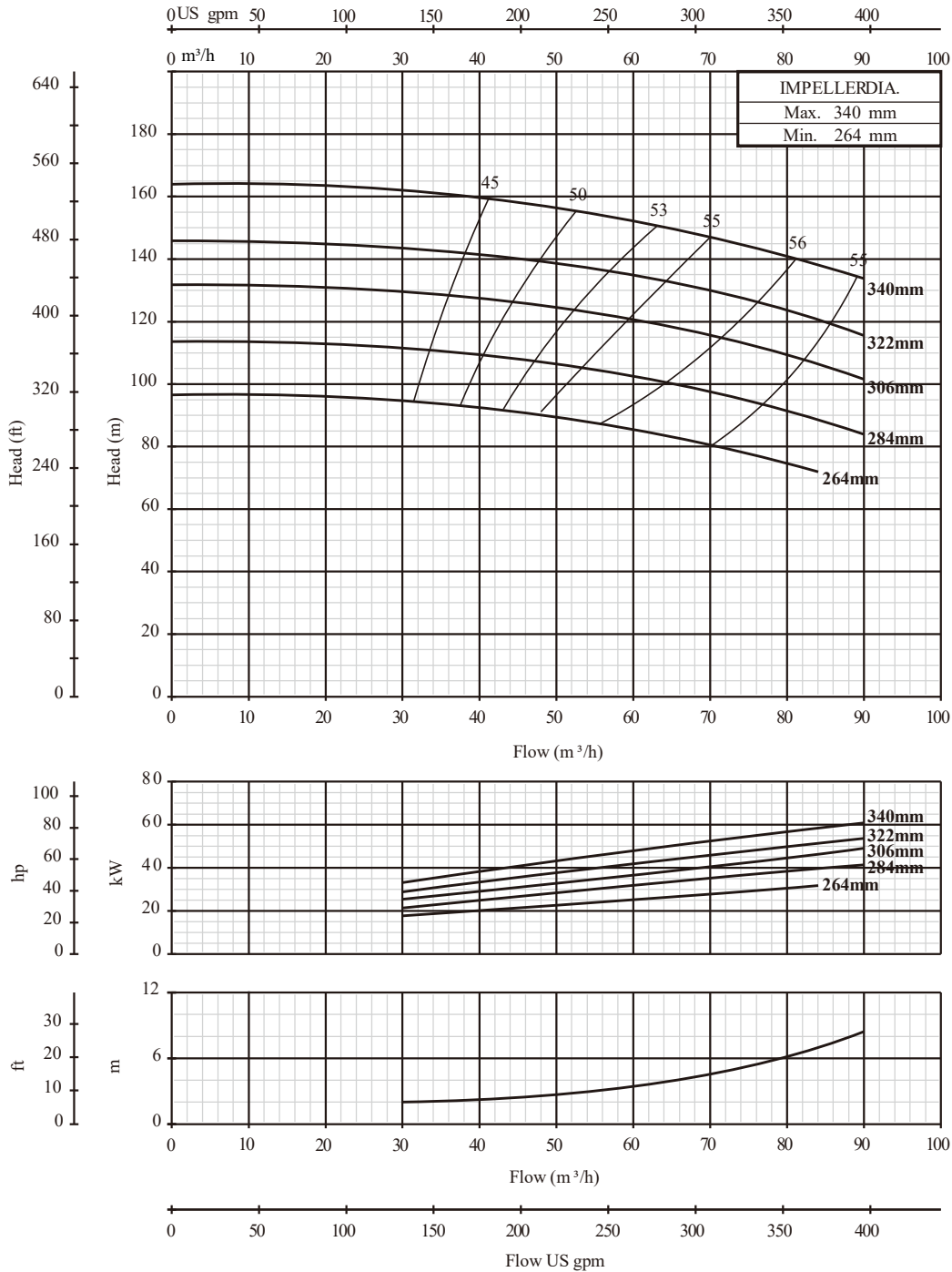

PERFORMANCE CURVE